

# STAMFORD®

## S5L1S-E4 Wdg.311 - Technical Data Sheet

### Standards

STAMFORD industrial alternators meet the requirements of the relevant parts of the IEC 60034 and the relevant sections of other international standards such as BS5000-3, ISO 8528-3, VDE 0530, NEMA MG1-32, CSA C22.2-100 and AS 60034. Other standards and certifications can be considered on request.

### Quality Assurance

Alternators are manufactured using production procedures having a quality assurance level to BS EN ISO 9001.

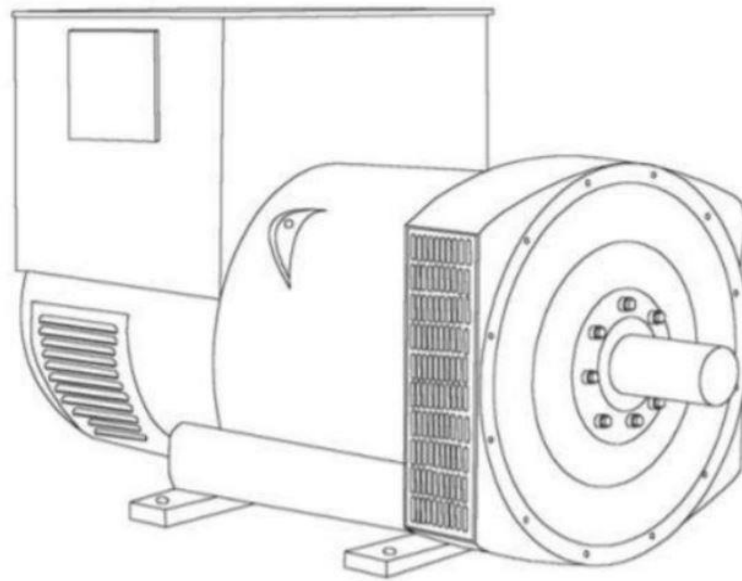

### Excitation and Voltage Regulators

| Excitation System  |              |       |        |        |                          |
|--------------------|--------------|-------|--------|--------|--------------------------|
| AVR Type           | AS440        | MX341 | MX321  | MX322  |                          |
| Voltage Regulation | ± 1%         | ± 1%  | ± 0.5% | ± 0.5% | with 4% Engine Governing |
| AVR Power          | Self-Excited | PMG   | PMG    | PMG    |                          |

|                                  |             |
|----------------------------------|-------------|
| No Load Excitation Voltage (V)   | 9.0 - 8.7   |
| No Load Excitation Current (A)   | 0.58 - 0.56 |
| Full Load Excitation Voltage (V) | 44          |
| Full Load Excitation Current (A) | 2.6         |
| Exciter Time Constant (seconds)  | 0.099       |

# STAMFORD

## S5L1S-E4 Wdg.311

| Electrical Data   |   |      |      |      |              |      |      |      |
|---|---|------|------|------|--------------|------|------|------|
| Insulation System   | H   |      |      |      |              |      |      |      |
| Stator Winding  | Double Layer Lap  |      |      |      |              |      |      |      |
| Winding Pitch   | 2/3   |      |      |      |              |      |      |      |
| Winding Leads   | 12  |      |      |      |              |      |      |      |
| Winding Number  | 311   |      |      |      |              |      |      |      |
| Number of Poles   | 4   |      |      |      |              |      |      |      |
| IP Rating   | IP23  |      |      |      |              |      |      |      |
| RFI Suppression   | BS EN 61000-6-2 & BS EN 61000-6-4, VDE 0875G, VDE 0875N.<br>Refer to factory for others |      |      |      |              |      |      |      |
| Waveform Distortion   | NO LOAD < 1.5% NON-DISTORTING BALANCED LINEAR LOAD < 5.0%                               |      |      |      |              |      |      |      |
| Short Circuit Ratio   | 1/Xd  |      |      |      |              |      |      |      |
| Steady State X/R Ratio                                      | 14.41   |      |      |      |              |      |      |      |
| 50 Hz   |   |      |      |      | 60 Hz        |      |      |      |
| Telephone Interference                                      | THF<2%  |      |      |      | TIF<50       |      |      |      |
| Cooling Air Flow  | 1.035 m³/sec  |      |      |      | 1.312 m³/sec |      |      |      |
| Voltage Series Star (V)                                     | 380   | 400  | 415  | 440  | 416          | 440  | 460  | 480  |
| Voltage Parallel Star (V)                                   | 190   | 200  | 208  | 220  | 208          | 220  | 230  | 240  |
| Voltage Series Delta (V)                                    | 220   | 230  | 240  | 254  | 240          | 254  | 266  | 277  |
| kVA Base Rating (Class H) for Reactance Values (kVA)        | 600   | 610  | 600  | 600  | 681          | 713  | 731  | 750  |
| Saturated Values in Per Unit at Base Ratings and Voltages   |   |      |      |      |              |      |      |      |
| Xd Dir. Axis Synchronous                                    | 3.14  | 2.88 | 2.63 | 2.34 | 3.57         | 3.34 | 3.13 | 2.95 |
| X'd Dir. Axis Transient                                     | 0.16  | 0.15 | 0.14 | 0.12 | 0.19         | 0.17 | 0.16 | 0.15 |
| X" d Dir. Axis Subtransient                                 | 0.12  | 0.11 | 0.10 | 0.09 | 0.14         | 0.13 | 0.12 | 0.11 |
| Xq Quad. Axis Reactance                                     | 2.45  | 2.25 | 2.06 | 1.83 | 2.79         | 2.61 | 2.45 | 2.31 |
| X" q Quad. Axis Subtransient                                | 0.26  | 0.24 | 0.22 | 0.20 | 0.30         | 0.28 | 0.26 | 0.25 |
| XL Stator Leakage Reactance                                 | 0.05  | 0.05 | 0.05 | 0.04 | 0.06         | 0.06 | 0.05 | 0.05 |
| X2 Negative Sequence Reactance                              | 0.17  | 0.16 | 0.15 | 0.13 | 0.20         | 0.19 | 0.17 | 0.16 |
| X0 Zero Sequence Reactance                                  | 0.09  | 0.08 | 0.07 | 0.07 | 0.10         | 0.09 | 0.09 | 0.08 |
| Unsaturated Values in Per Unit at Base Ratings and Voltages |   |      |      |      |              |      |      |      |
| Xd Dir. Axis Synchronous                                    | 3.77  | 3.46 | 3.16 | 2.81 | 4.28         | 4.01 | 3.76 | 3.54 |
| X'd Dir. Axis Transient                                     | 0.19  | 0.17 | 0.16 | 0.14 | 0.21         | 0.20 | 0.19 | 0.18 |
| X" d Dir. Axis Subtransient                                 | 0.14  | 0.13 | 0.12 | 0.10 | 0.16         | 0.15 | 0.14 | 0.13 |
| Xq Quad. Axis Reactance                                     | 2.53  | 2.32 | 2.12 | 1.88 | 2.87         | 2.69 | 2.52 | 2.37 |
| X" q Quad. Axis Subtransient                                | 0.31  | 0.29 | 0.26 | 0.23 | 0.36         | 0.33 | 0.31 | 0.30 |
| XL Stator Leakage Reactance                                 | 0.06  | 0.06 | 0.05 | 0.05 | 0.07         | 0.07 | 0.06 | 0.06 |
| Xlr Rotor Leakage Reactance                                 | 0.09  | 0.08 | 0.08 | 0.07 | 0.10         | 0.10 | 0.09 | 0.09 |
| X2 Negative Sequence Reactance                              | 0.21  | 0.19 | 0.18 | 0.16 | 0.24         | 0.22 | 0.21 | 0.20 |
| X0 Zero Sequence Reactance                                  | 0.10  | 0.09 | 0.09 | 0.08 | 0.12         | 0.11 | 0.10 | 0.10 |

# STAMFORD

## S5L1S-E4 Wdg.311

| Time Constants (Seconds)                                       |   |                         |
|--|---|-------------------------|
| T'd Transient Time Const.                                      | 0.080   |                         |
| T''d Sub-Transient Time Const.                                 | 0.012   |                         |
| T'do O.C. Field Time Const.                                    | 2.500   |                         |
| Ta Armature Time Const.  | 0.019   |                         |
| T''q Sub-Transient Time Const.                                 | 0.0190  |                         |
| Resistances in Ohms ( $\Omega$ ) at 22°C                       |   |                         |
| Stator Winding Resistance (Ra), per phase for series connected | 0.00430   |                         |
| Rotor Winding Resistance (Rf)                                  | 1.96  |                         |
| Exciter Stator Winding Resistance                              | 17  |                         |
| Exciter Rotor Winding Resistance per phase                     | 0.092   |                         |
| PMG Phase Resistance (Rpmg) per phase                          | 1.91  |                         |
| Positive Sequence Resistance (R1)                              | 0.0054  |                         |
| Negative Sequence Resistance (R2)                              | 0.0062  |                         |
| Zero Sequence Resistance (R0)                                  | 0.0054  |                         |
| Saturation Factors   | 400V  | 480V                    |
| SG1.0  | 0.268   | 0.313                   |
| SG1.2  | 1.149   | 1.049                   |
| Mechanical Data  |   |                         |
| Shaft and Keys   | All alternator rotors are dynamically balanced to better than ISO 21940-11 Grade 2.5 for minimum vibration in operation. Two bearing generators are balanced with a half key. |                         |
|  | 1 Bearing   | 2 Bearing               |
| SAE Adaptor  | SAE 00, 0, 0.5, 1   | SAE 00, 0, 0.5, 1       |
| Moment of Inertia  | 8.9828 kgm <sup>2</sup>   | 8.7049 kgm <sup>2</sup> |
| Weight Wound Stator  | 722kg   | 722kg                   |
| Weight Wound Rotor   | 617kg   | 588kg                   |
| Weight Complete Alternator                                     | 1543kg  | 1535kg                  |
| Shipping weight in a Crate                                     | 1635kg  | 1625kg                  |
| Packing Crate Size   | 166x87x124(cm)  | 166x87x124(cm)          |
| Maximum Over Speed   | 2250 RPM for two minutes  |                         |
| Bearing Drive End  | -   | BALL.6220(ISO)          |
| Bearing Non-Drive End  | BALL.6314(ISO)  | BALL.6314(ISO)          |

# STAMFORD®

S5L1S-E4 Wdg.311

## THREE PHASE EFFICIENCY CURVES

50Hz

60Hz

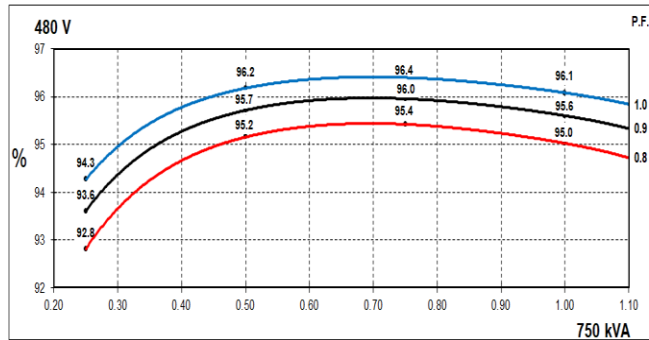
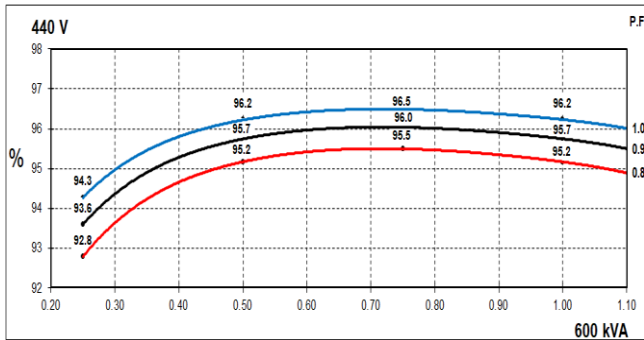
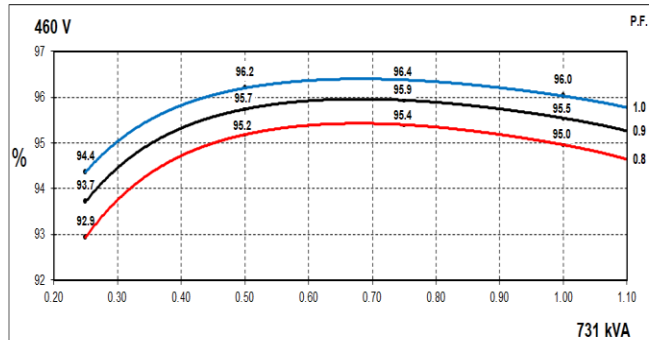
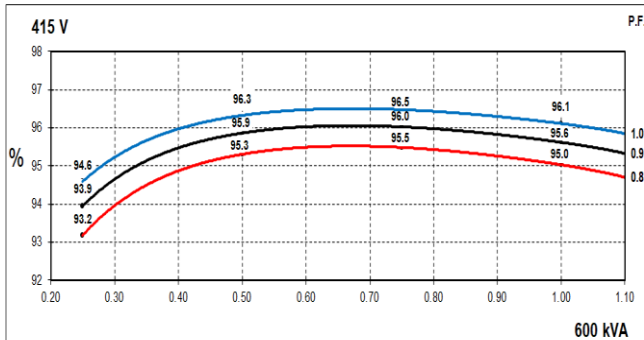
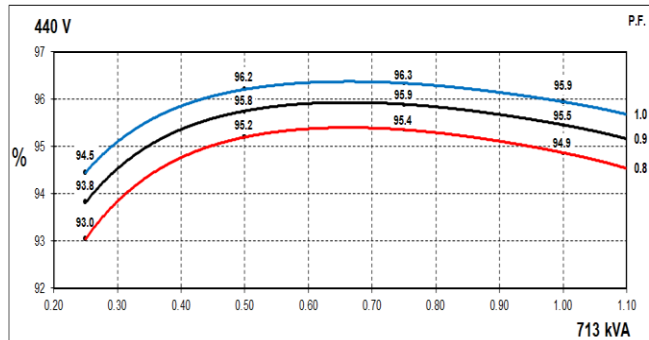
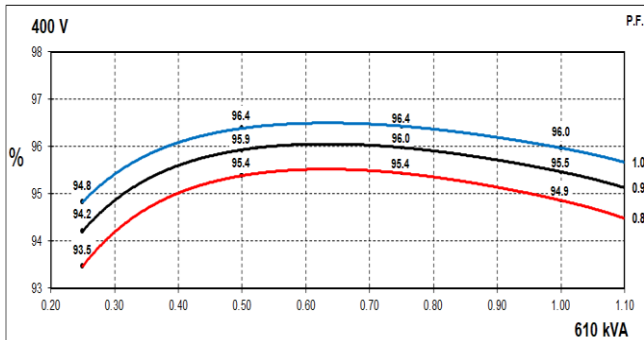
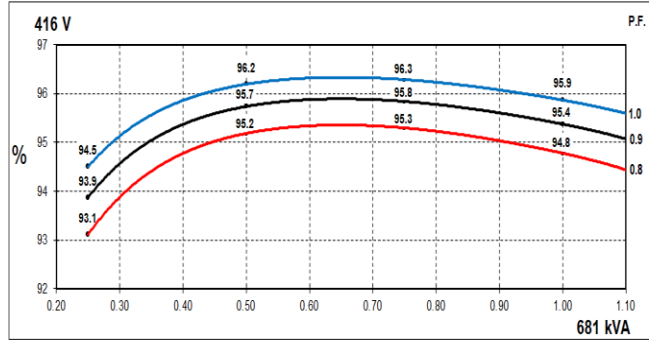
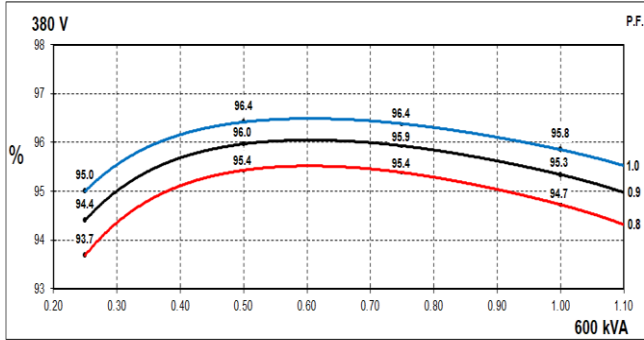

# STAMFORD

S5L1S-E4 Wdg.311

## Locked Rotor Motor Starting Curves - Separately Excited

**50Hz**

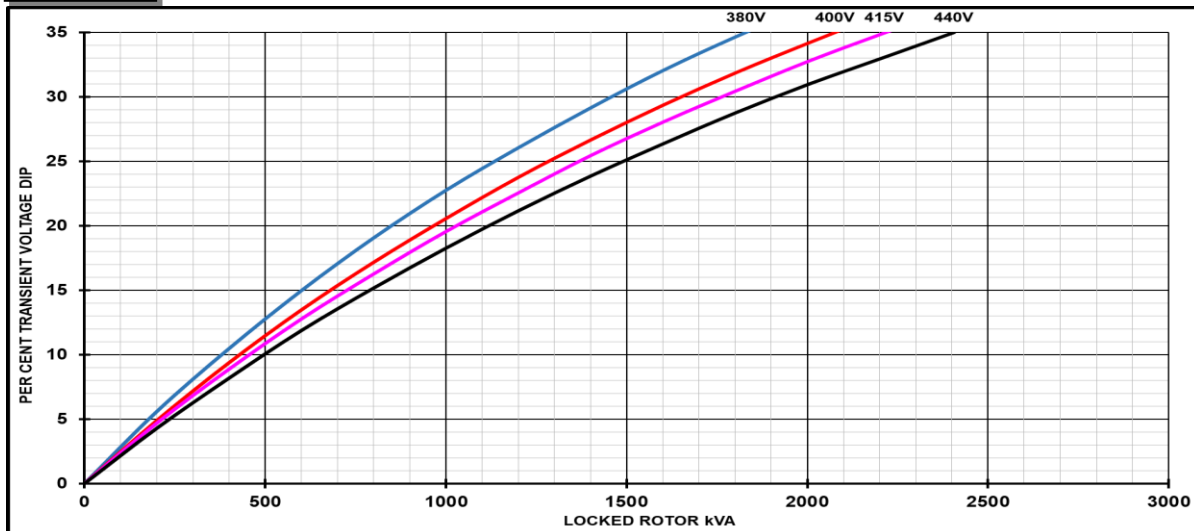

**60Hz**

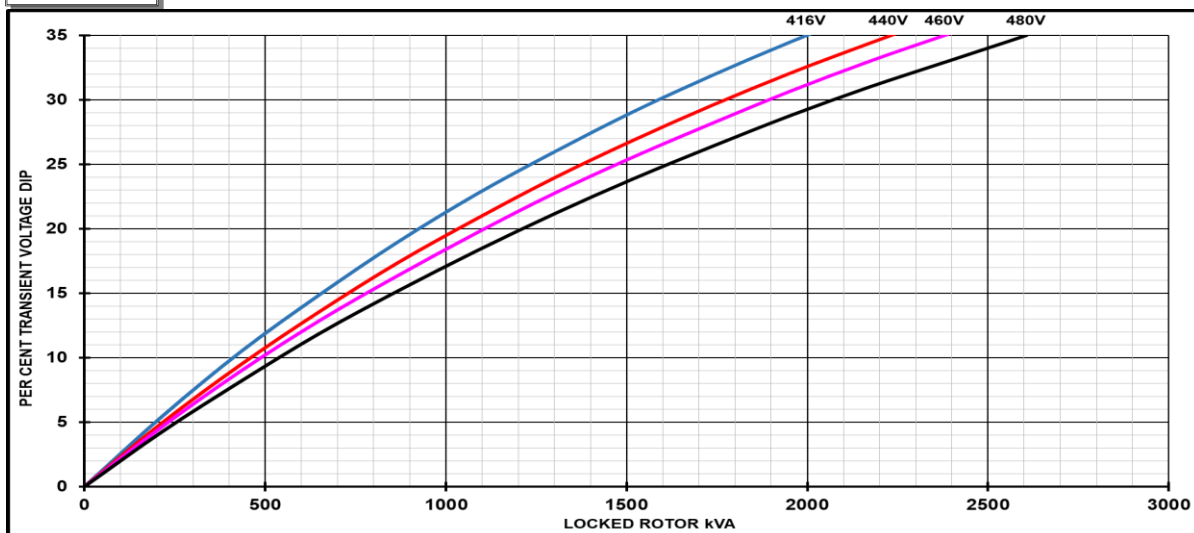

| Transient Voltage Dip Scaling Factor |                | Transient Voltage Rise Scaling Factor |                |
|--------------------------------------|----------------|---------------------------------------|----------------|
| Lagging PF                           | Scaling Factor | Lagging PF                            | Scaling Factor |
| <= 0.4                               | 1.00           | <= 0.4                                | 1.25           |
| 0.5                                  | 0.95           | 0.5                                   | 1.20           |
| 0.6                                  | 0.90           | 0.6                                   | 1.15           |
| 0.7                                  | 0.86           | 0.7                                   | 1.10           |
| 0.8                                  | 0.83           | > 0.7                                 | 1.00           |
| 0.9                                  | 0.75           |                                       |                |
| 0.95                                 | 0.70           |                                       |                |
| 1                                    | 0.65           |                                       |                |

**Note:** To determine % Transient Voltage Dip or Voltage Rise at various PF, multiply the % Voltage Dip from the curve directly by the Scaling Factor.

# STAMFORD

S5L1S-E4 Wdg.311

## Locked Rotor Motor Starting Curves - Self Excited

**50Hz**

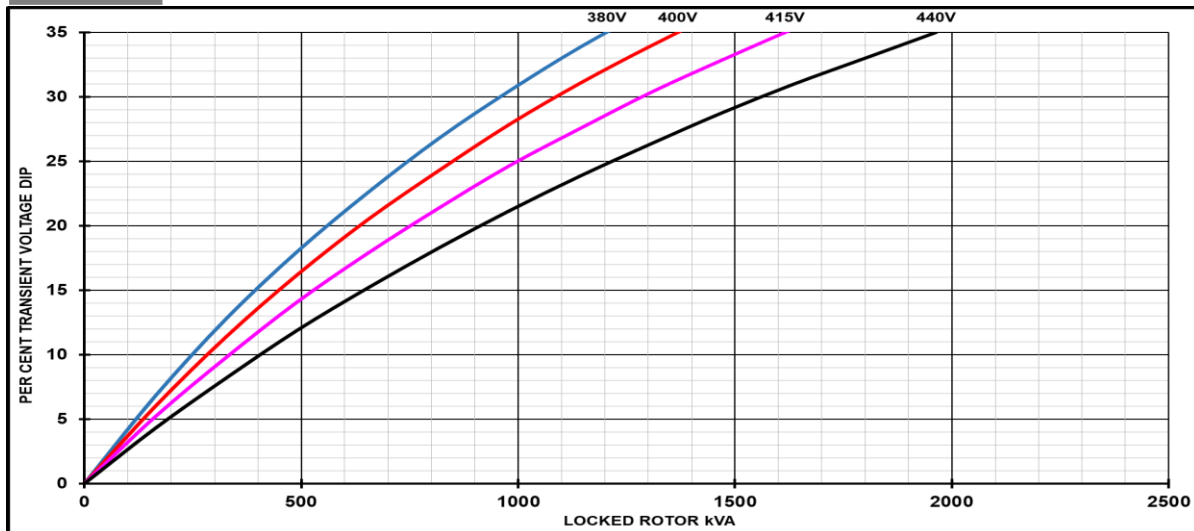

**60Hz**

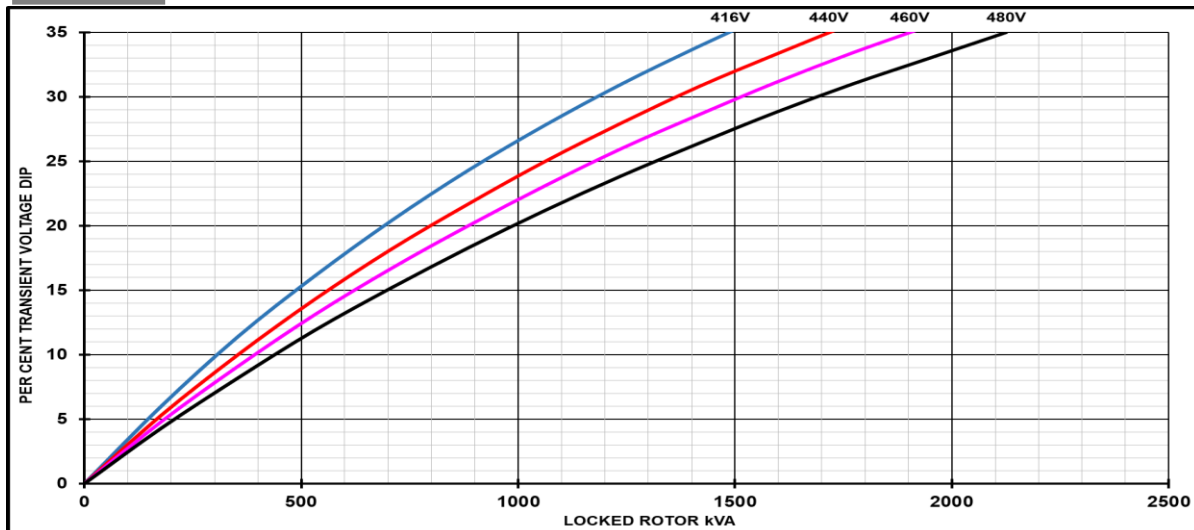

| Transient Voltage Dip Scaling Factor |                | Transient Voltage Rise Scaling Factor |                |
|--------------------------------------|----------------|---------------------------------------|----------------|
| Lagging PF                           | Scaling Factor | Lagging PF                            | Scaling Factor |
| <= 0.4                               | 1.00           | <= 0.4                                | 1.25           |
| 0.5                                  | 0.95           | 0.5                                   | 1.20           |
| 0.6                                  | 0.90           | 0.6                                   | 1.15           |
| 0.7                                  | 0.86           | 0.7                                   | 1.10           |
| 0.8                                  | 0.83           | > 0.7                                 | 1.00           |
| 0.9                                  | 0.75           |                                       |                |
| 0.95                                 | 0.70           |                                       |                |
| 1                                    | 0.65           |                                       |                |

**Note:** To determine % Transient Voltage Dip or Voltage Rise at various PF, multiply the % Voltage Dip from the curve directly by the Scaling Factor.

# STAMFORD®

## S5L1S-E4 Wdg.311

### Three-phase Short Circuit Decrement Curve - Separately Excited

**50Hz**

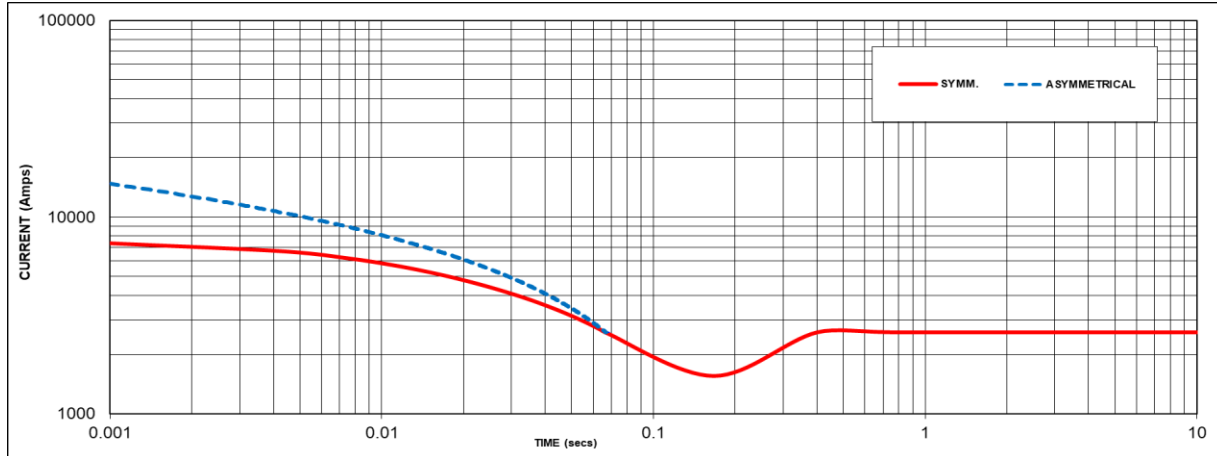

Sustained Short Circuit = 2600 Amps

**60Hz**

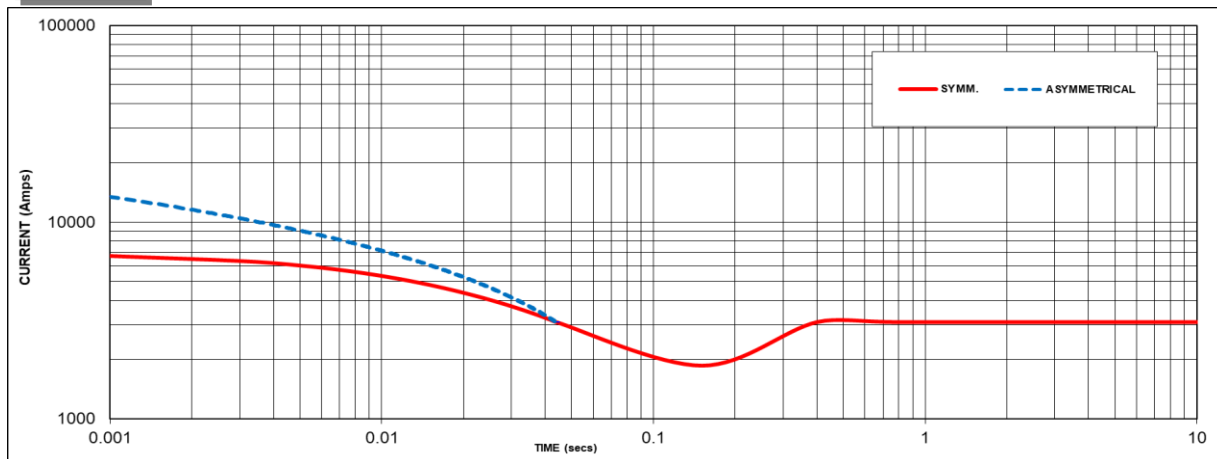

Sustained Short Circuit = 3100 Amps

**Note 1**

The following multiplication factors should be used to adjust the values from curve between time 0.001 seconds and the minimum current point in respect of nominal operating voltage :

| 50Hz    |        | 60Hz    |        |
|---------|--------|---------|--------|
| Voltage | Factor | Voltage | Factor |
| 380V    | X 1.00 | 416V    | X 1.00 |
| 400V    | X 1.05 | 440V    | X 1.06 |
| 415V    | X 1.09 | 460V    | X 1.10 |
| 440V    | X 1.16 | 480V    | X 1.15 |

The sustained current value is constant irrespective of voltage level

If MX322 or digital AVR is used, the sustained short-circuit current value is to be multiplied by a factor of 1.1.

**Note 2**

The following multiplication factor should be used to convert the values calculated in accordance with NOTE 1 to those applicable to the various types of short circuit :

|                         | 3-phase | 2-phase L-L | 1-phase L-N |
|-------------------------|---------|-------------|-------------|
| Instantaneous           | x 1.00  | x 0.87      | x 1.30      |
| Minimum                 | x 1.00  | x 1.80      | x 3.20      |
| Sustained               | x 1.00  | x 1.50      | x 2.50      |
| Max. sustained duration | 10 sec. | 5 sec.      | 2 sec.      |

**Note 3**

All other times are unchanged

Curves are drawn for Star connections under no-load excitation at rated speeds. For other connection (where applicable) the following multipliers should be applied to current values as shown :

Parallel Star = Curve current value X 2

Series Delta = Curve current value X 1.732

# STAMFORD

S5L1S-E4 Wdg.311

## Typical Alternator Operating Charts

**400V/50Hz**

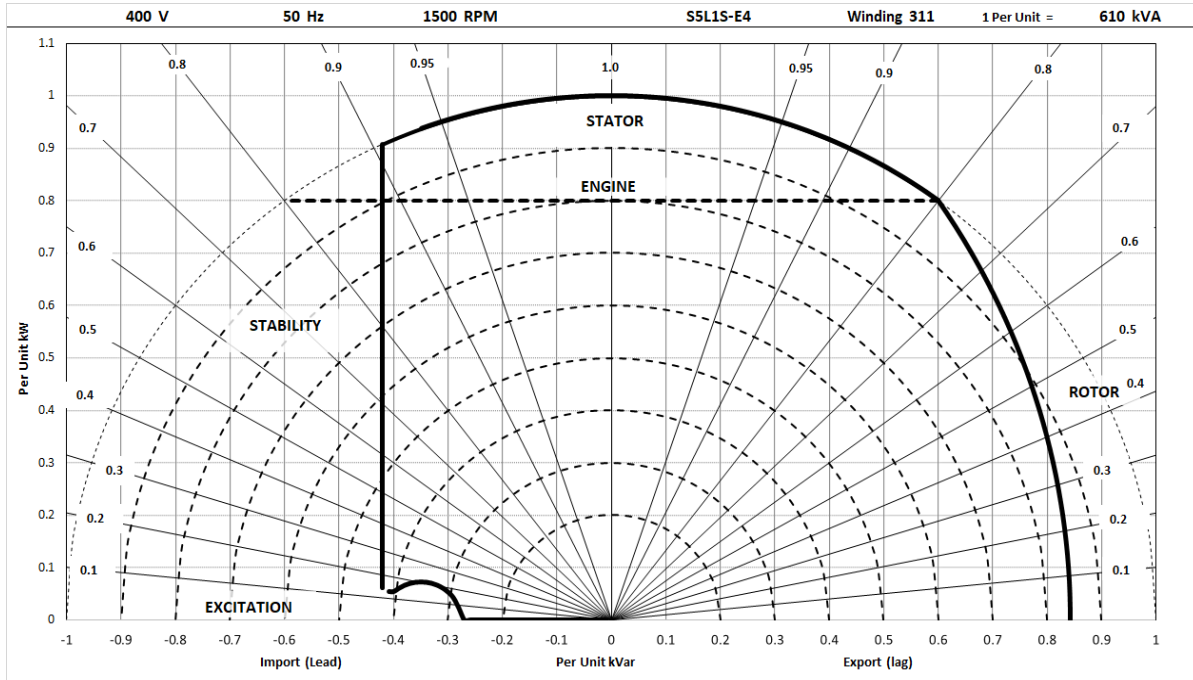

**480V/60Hz**

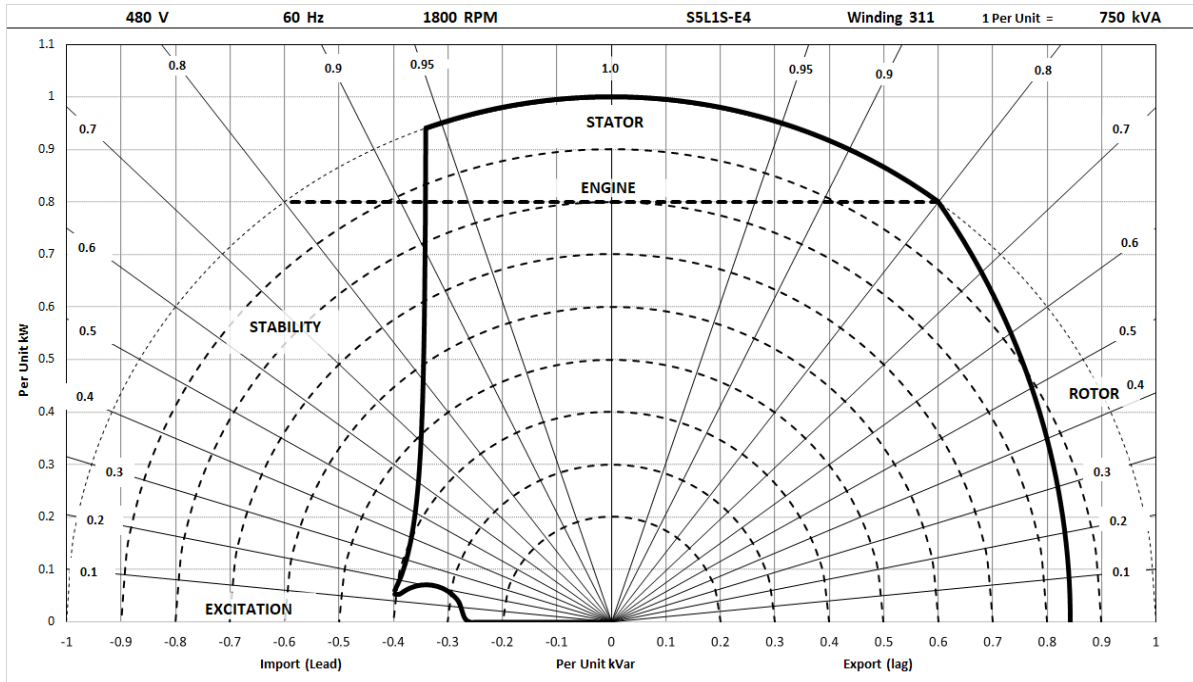



# STAMFORD®

## S5L1S-E4 Wdg.311

### RATINGS AT 0.8 POWER FACTOR

| Class - Temp Rise |                   | Standby - 163/27°C |      |      |      | Standby - 150/40°C |      |      |      | Cont. H - 125/40°C |      |      |      | Cont. F - 105/40°C |      |      |      |
|-------------------|-------------------|--------------------|------|------|------|--------------------|------|------|------|--------------------|------|------|------|--------------------|------|------|------|
| <b>50<br/>Hz</b>  | Series Star (V)   | 380                | 400  | 415  | 440  | 380                | 400  | 415  | 440  | 380                | 400  | 415  | 440  | 380                | 400  | 415  | 440  |
|                   | Parallel Star (V) | 190                | 200  | 208  | 220  | 190                | 200  | 208  | 220  | 190                | 200  | 208  | 220  | 190                | 200  | 208  | 220  |
|                   | Series Delta (V)  | 220                | 230  | 240  | 254  | 220                | 230  | 240  | 254  | 220                | 230  | 240  | 254  | 220                | 230  | 240  | 254  |
|                   | kVA               | 660                | 665  | 660  | 660  | 636                | 640  | 636  | 636  | 600                | 610  | 600  | 600  | 550                | 560  | 550  | 550  |
|                   | kW                | 528                | 532  | 528  | 528  | 509                | 512  | 509  | 509  | 480                | 488  | 480  | 480  | 440                | 448  | 440  | 440  |
|                   | Efficiency (%)    | 94.3               | 94.5 | 94.7 | 94.9 | 94.5               | 94.7 | 94.8 | 95.0 | 94.7               | 94.9 | 95.0 | 95.2 | 95.0               | 95.1 | 95.2 | 95.3 |
|                   | kW Input          | 560                | 563  | 557  | 556  | 538                | 541  | 536  | 535  | 507                | 514  | 505  | 504  | 463                | 471  | 462  | 462  |

|                  |                   |      |      |      |      |      |      |      |      |      |      |      |      |      |      |      |      |
|------------------|-------------------|------|------|------|------|------|------|------|------|------|------|------|------|------|------|------|------|
| <b>60<br/>Hz</b> | Series Star (V)   | 416  | 440  | 460  | 480  | 416  | 440  | 460  | 480  | 416  | 440  | 460  | 480  | 416  | 440  | 460  | 480  |
|                  | Parallel Star (V) | 208  | 220  | 230  | 240  | 208  | 220  | 230  | 240  | 208  | 220  | 230  | 240  | 208  | 220  | 230  | 240  |
|                  | Series Delta (V)  | 240  | 254  | 266  | 277  | 240  | 254  | 266  | 277  | 240  | 254  | 266  | 277  | 240  | 254  | 266  | 277  |
|                  | kVA               | 738  | 769  | 798  | 819  | 719  | 750  | 780  | 800  | 681  | 713  | 731  | 750  | 625  | 650  | 663  | 675  |
|                  | kW                | 590  | 615  | 638  | 655  | 575  | 600  | 624  | 640  | 545  | 570  | 585  | 600  | 500  | 520  | 530  | 540  |
|                  | Efficiency (%)    | 94.5 | 94.6 | 94.7 | 94.8 | 94.6 | 94.7 | 94.8 | 94.8 | 94.8 | 94.9 | 95.0 | 95.0 | 95.0 | 95.1 | 95.2 | 95.2 |
|                  | kW Input          | 625  | 650  | 674  | 691  | 608  | 634  | 658  | 675  | 575  | 601  | 616  | 631  | 526  | 547  | 557  | 567  |

#### De-rates

All values tabulated above are subject to the following reductions:

- 5% when air inlet filters are fitted
- 3% for every 500 meters by which the operating altitude exceeds 1000 meters above mean sea level
- 3% for every 5°C by which the operational ambient temperature exceeds 40°C @ Class H temperature rise (please refer to applications for ambient temperature de-rates at other temperature rise classes)
- For any other operating conditions impacting the cooling circuit please refer to applications

Note: Requirement for operating in an ambient exceeding 60°C and altitude exceeding 4000 meters (for <690V) or 1500 meters (for >690V) must be referred to applications.

#### Dimensional and Torsional Drawing

For dimensional and torsional information please refer to the alternator General Arrangement and rotor drawings available on our website (<http://stamford-avk.com/>)

**Note:** Continuous development of our products means that the information contained in our data sheets can change without notice, and specifications should always be confirmed with Cummins Generator Technologies prior to purchase.



Follow us @stamfordavk



Cummins Generator Technologies



View our videos at [youtube.com/stamfordavk](https://youtube.com/stamfordavk)

[stamford-avk.com](https://stamford-avk.com)

**For Applications Support:  
applications@cummins.com**

**For Customer Service:  
emea.service@cummins.com**

**For General Enquiries:  
Stamford-avk@cummins.com**

Copyright 2020. Cummins Generator Technologies Ltd. All rights reserved.  
Cummins and the Cummins logo are registered trade marks of Cummins Inc.  
STAMFORD is a registered trade mark of Cummins Generator Technologies Ltd.

