

# Technical Data

## 2200 Series

## 2206A-E13TAG2

## 2206A-E13TAG3

### Electropak

#### Basic technical data

Number of cylinders... 6  
 Cylinder arrangement... vertical in-line  
 Cycle... 4 stroke  
 Induction system... turbocharged, air-to-air charge cooling  
 Combustion system... direct injection diesel  
 Compression ratio... 16,3:1  
 Bore... 130 mm  
 Stroke... 157 mm  
 Cubic capacity... 12,5 litres  
 Direction of rotation... anticlockwise when viewed from flywheel  
 Firing order (number 1 cylinder furthest from flywheel) 1-5-3-6-2-4  
 Estimated total weight of Electropak (dry)... 1478 kg  
 Estimated total weight of Electropak (wet)... 1582 kg

#### Overall dimensions - Electropak

-height... 1725 mm  
 -length (air cleaner fitted)... 2410 mm  
 -width... 1120 mm

#### Moments of inertia (mk<sup>2</sup>)

Engine... 1,36 kgm<sup>2</sup>  
 Flywheel... 1,41 kgm<sup>2</sup>

#### Centre of gravity

Forward of rear face of cylinder block... 650 mm  
 Above crankshaft centre line... 250 mm

#### Cyclic irregularity

-1500 rev/min... 1,54  
 -1800 rev/min... 1,82

#### Performance

**Note:** All data based on operation to ISO 3046-1, BS5514 AND DIN 6271 standard reference conditions.

All data based on 42584 MJ/kg calorific value for diesel conforming to specification BS2869 ClassA2

All ratings certified to within  $\pm 3\%$   
 Steady state speed capability at constant load - G2...  $\pm 0,25\%$

#### Test conditions

-air temperature... 25 °C  
 -barometric pressure... 100 kPa  
 -relative humidity... 30 %  
 -air inlet restriction at maximum power (nominal)... 2,5 kPa  
 -exhaust back pressure at maximum power (nominal)... 6,8 kPa  
 -fuel temperature (inlet pump)... 40 °C

#### Sound level

Sound pressure level (exhaust piped away, cooling pack and air cleaner fitted)  
 -1500 rev/min... 102 dB(A)  
 -1800 rev/min... 104,6 dB(A)  
 If the engine is to operate in ambient conditions other than those of the test conditions, suitable adjustments must be made for these changes. For full details, contact Perkins Technical Service Department.

**Emissions capability:** All 2206A ratings are to 'best fuel consumption' and do not comply to Harmonised International regulation Emission Limits.

#### General installation - 2206A-E13TAG2

Designation	Units	Prime	Standby	Prime	Standby
		50Hz @ 1500 rev/min		60Hz @ 1800 rev/min	
Gross engine power	kWb	324,2	368,4	373,4	406,5
Brake mean effective pressure	kPa	2061	2355	1984	2171
Combustion air flow (at rated speed)	m <sup>3</sup> /min	21,3	23,6	27,4	29,0
Exhaust gas flow (Max.)	m <sup>3</sup> /min	56,6	64,8	67,5	73,5
Exhaust gas mass flow	kg/min	25,1	27,8	32,6	34,5
Exhaust gas temperature (turbocharger outlet)	°C	630	630	630	660
Boost pressure ratio		2,8	3,2	3,1	3,4
Overall thermal efficiency (nett)	%	41,3	40,8	40,7	40,3
Typical genset electrical output (0.8pf 25 °C)	kWe	280	320	320	350
	kVA	350	400	400	438
Assumed alternator efficiency	%	92		92	
<b>Energy balance</b>					
Energy in fuel	kWt	739,9	854,1	857,0	945,7
Energy in power output (gross)	kWb	324,2	368,4	373,4	406,5
Energy to additional losses	kWb	4,9	5,5	5,6	6,1
Energy to cooling fan	kWm	14		19	
Energy in power output (nett)	kWt	305,3	348,9	348,8	381,4
Energy to exhaust	kWt	213,2	245,3	244,7	273,7
Energy to coolant and lubricating oil	kWt	113,5	128,5	130,2	139,5
Energy to charge cooler	kWt	64,8	79,7	68,4	76,5
Energy to radiation	kWt	24,1	32,2	40,3	49,5

## General installation - 2206A-E13TAG3

Designation	Units	Prime	Standby	Prime	Standby
		50Hz @ 1500 rev/min		60Hz @ 1800 rev/min	
Gross engine power	kWb	368,4	412,5	373,4	406,5
Brake mean effective pressure	kPa	2344	2637	1984	2171
Combustion air flow (at rated speed)	m <sup>3</sup> /min	24,3	26,4	27,4	29,0
Exhaust gas flow (Max.)	m <sup>3</sup> /min	64,6	72,5	67,5	73,5
Exhaust gas mass flow	kg/min	28,1	30,9	32,6	34,5
Exhaust gas temperature (turbocharger outlet)	°C	630	630	660	660
Boost pressure ratio		3,2	3,5	3,1	3,4
Overall thermal efficiency (nett)	%	41,4	40,9	40,7	40,3
Typical genset electrical output (0.8pf 25 °C)	kWe	320	360	320	350
	kVA	400	450	400	438
Assumed alternator efficiency	%	92		92	
<b>Energy balance</b>					
Energy in fuel	kWt	842,6	958,2	857,0	945,7
Energy in power output (gross)	kWb	368,4	412,5	373,4	406,5
Energy to additional losses	kWb	5,5	6,2	5,6	6,1
Energy to cooling fan	kWm	14		19	
Energy in power output (nett)	kWt	348,9	392,3	348,8	381,4
Energy to exhaust	kWt	252,6	290,4	244,7	273,7
Energy to coolant and lubricating oil	kWt	127,3	139,9	130,2	139,5
Energy to charge cooler	kWt	60,3	75,5	68,4	76,5
Energy to radiation	kWt	34,0	39,8	40,3	49,6

## Rating definitions

### Prime power

Variable load. Unlimited hours usage with an average load factor of 70% of the published Prime Power rating over each 24 hour period. A 10% overload is available for 1 hour in every 12 hours of operation

### Standby power

Variable load. Limited to 500 hours annual usage up to 300 hours of which may be continuous running, No overload is permitted

2206A-E13TAG2 and 2206A-E13TAG3 - GA Z13622 (50Hz)

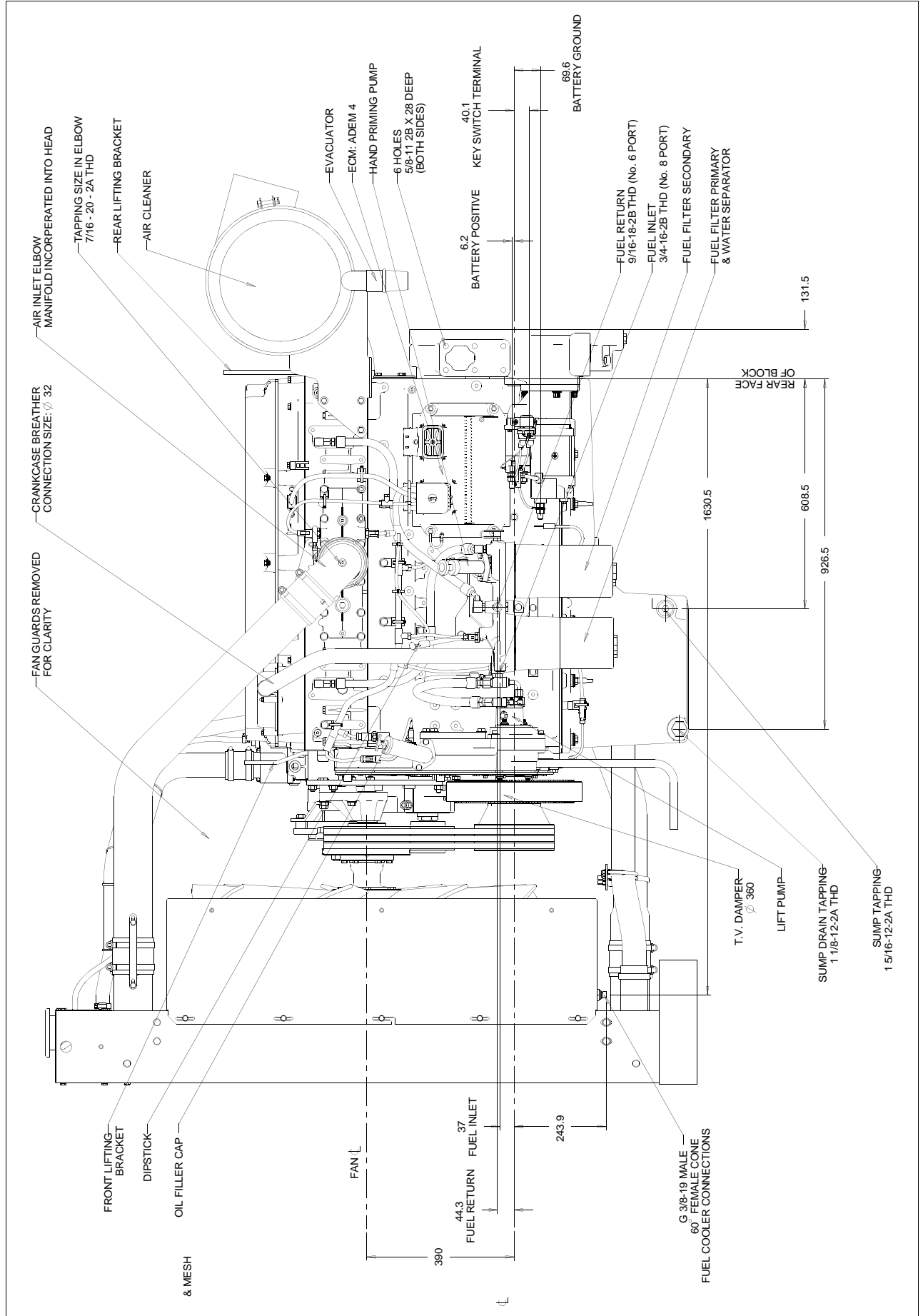

2206A-E13TAG2 and 2206A-E13TAG3 - GA Z13622 (50Hz)

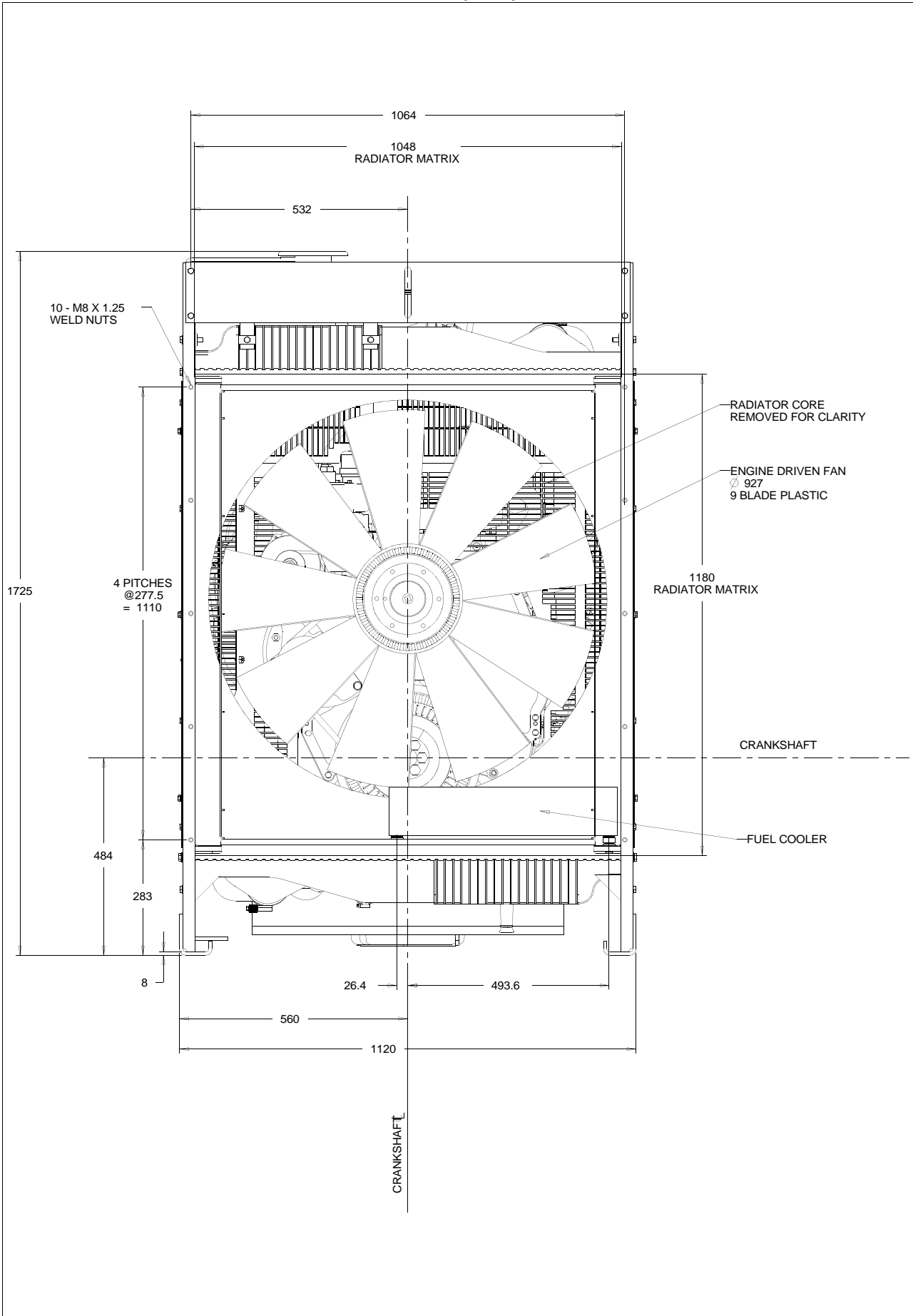

2206A-E13TAG2 and 2206A-E13TAG3 - GA Z13622 (50Hz)

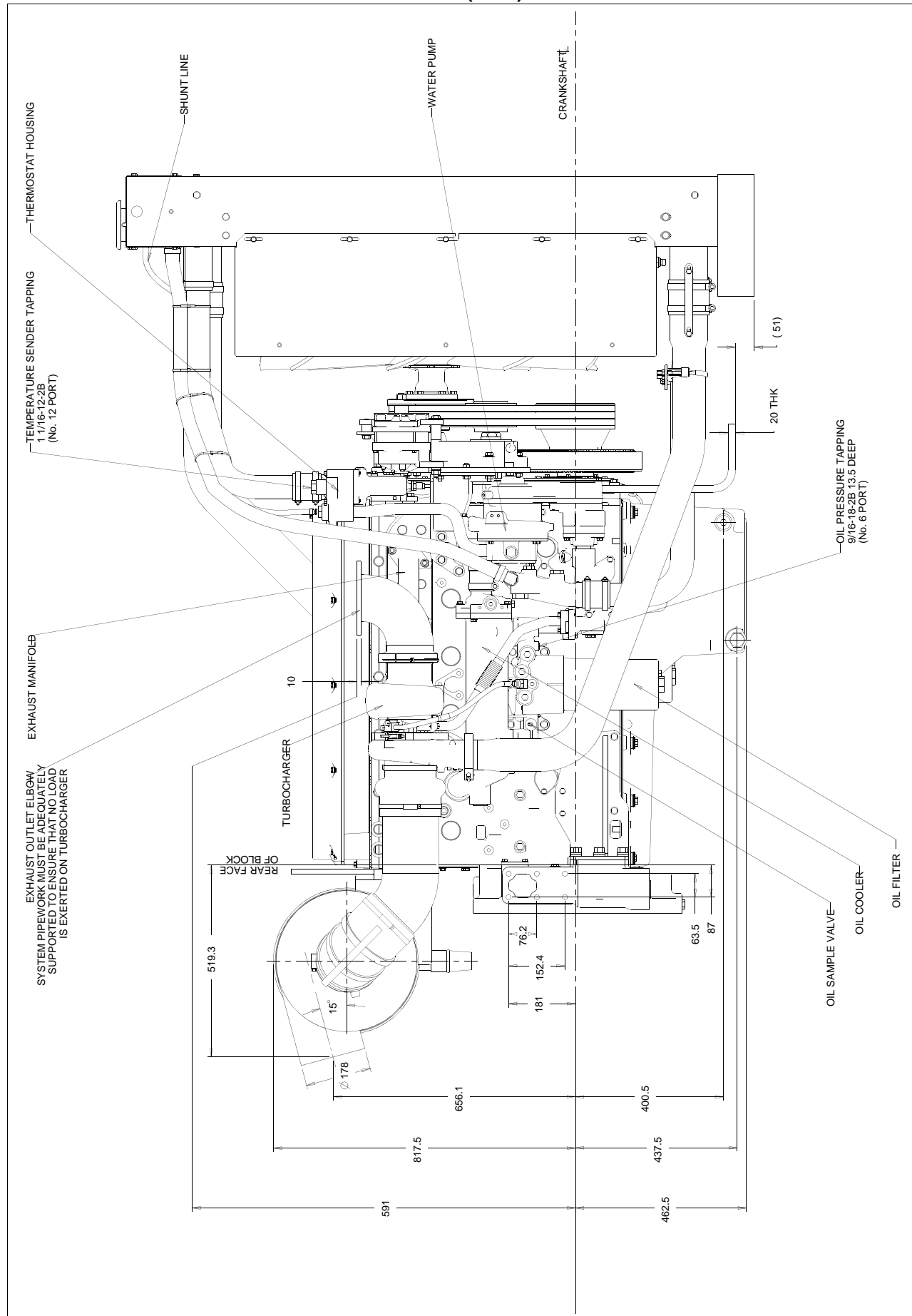

2206A-E13TAG2 and 2206A-E13TAG3 - GA Z13622 (50Hz)

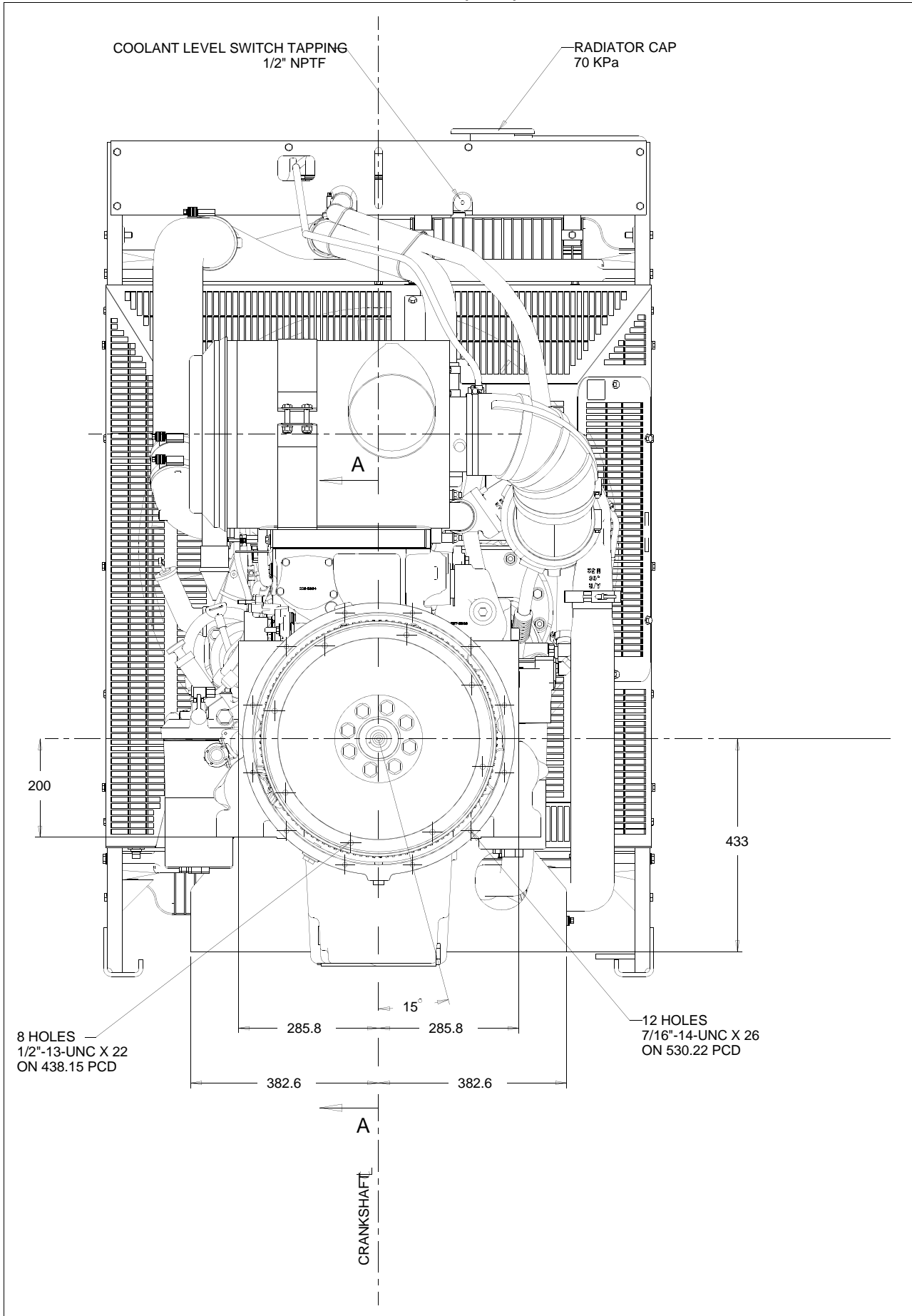

2206A-E13TAG2 and 2206A-E13TAG3 - GA Z13622 (50Hz)

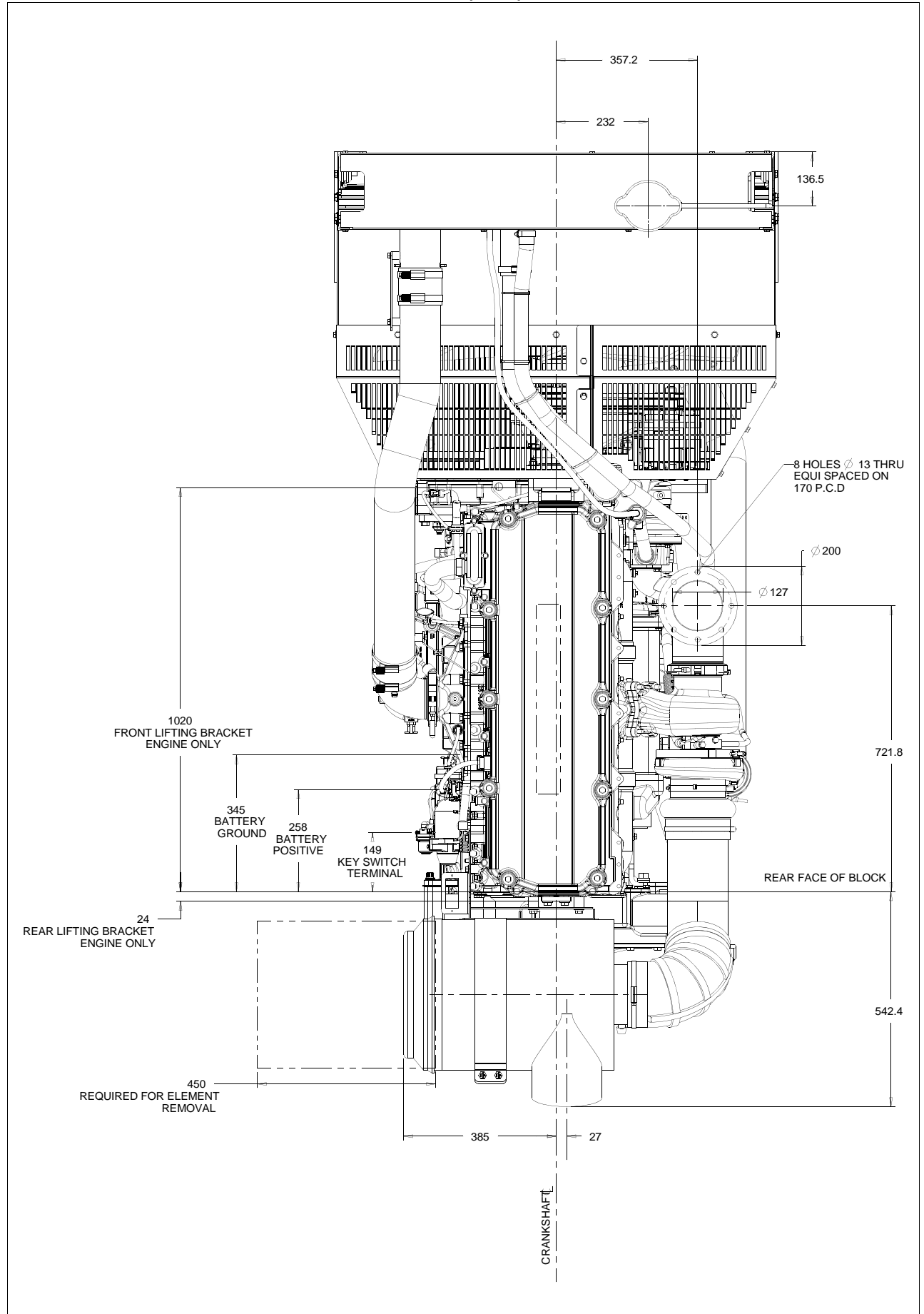

**2206A-E13TAG2 and 2206A-E13TAG3 - GA Z13622 (50Hz)**

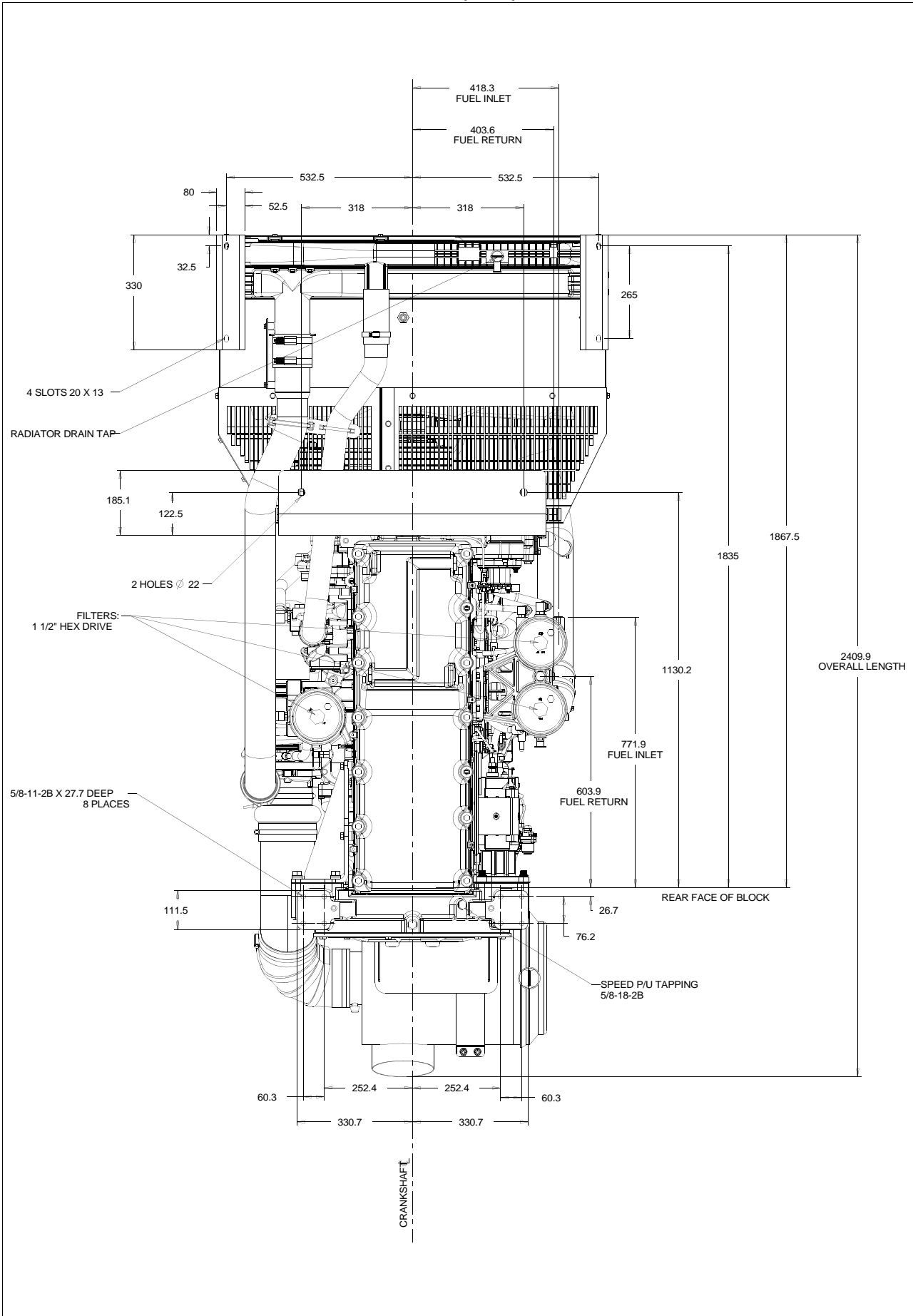



**2206A-E13TAG2 and 2206A-E13TAG3 - GA Z13620 (50Hz)**

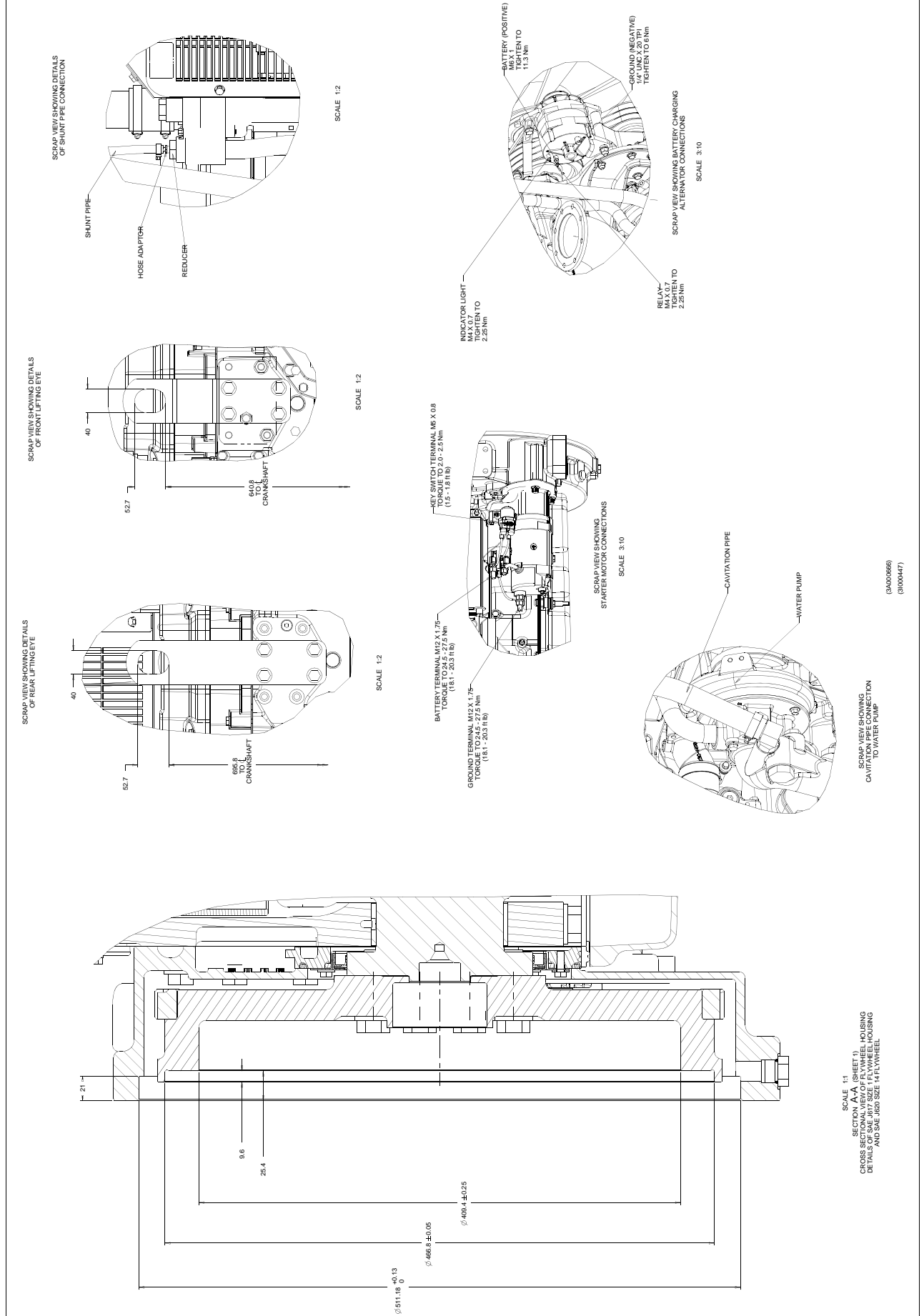

2206A-E13TAG2 and 2206A-E13TAG3 - GA Z13620 (50Hz)

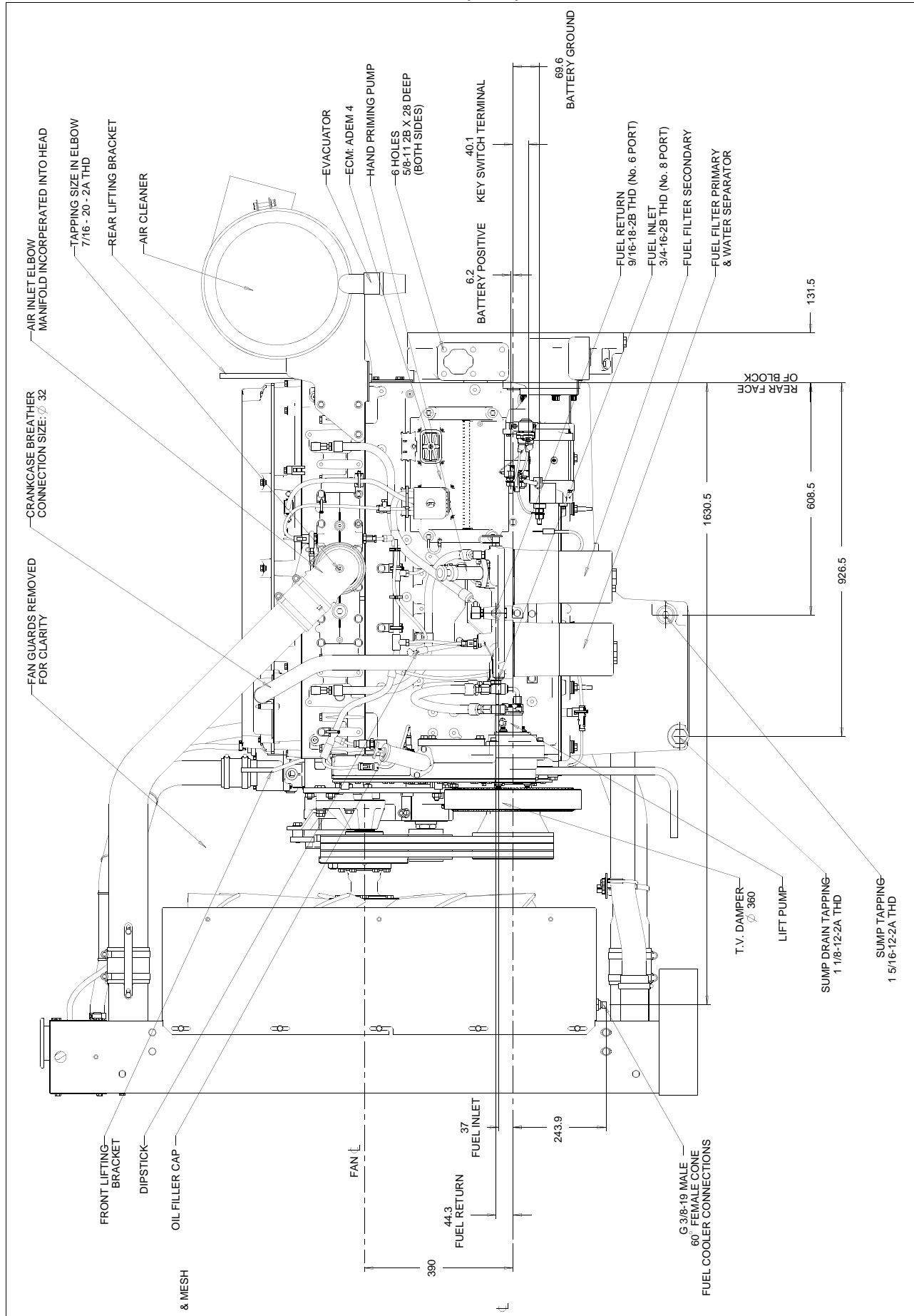

# 2206A-E13TAG2 and 2206A-E13TAG3 - GA Z13620 (50Hz)

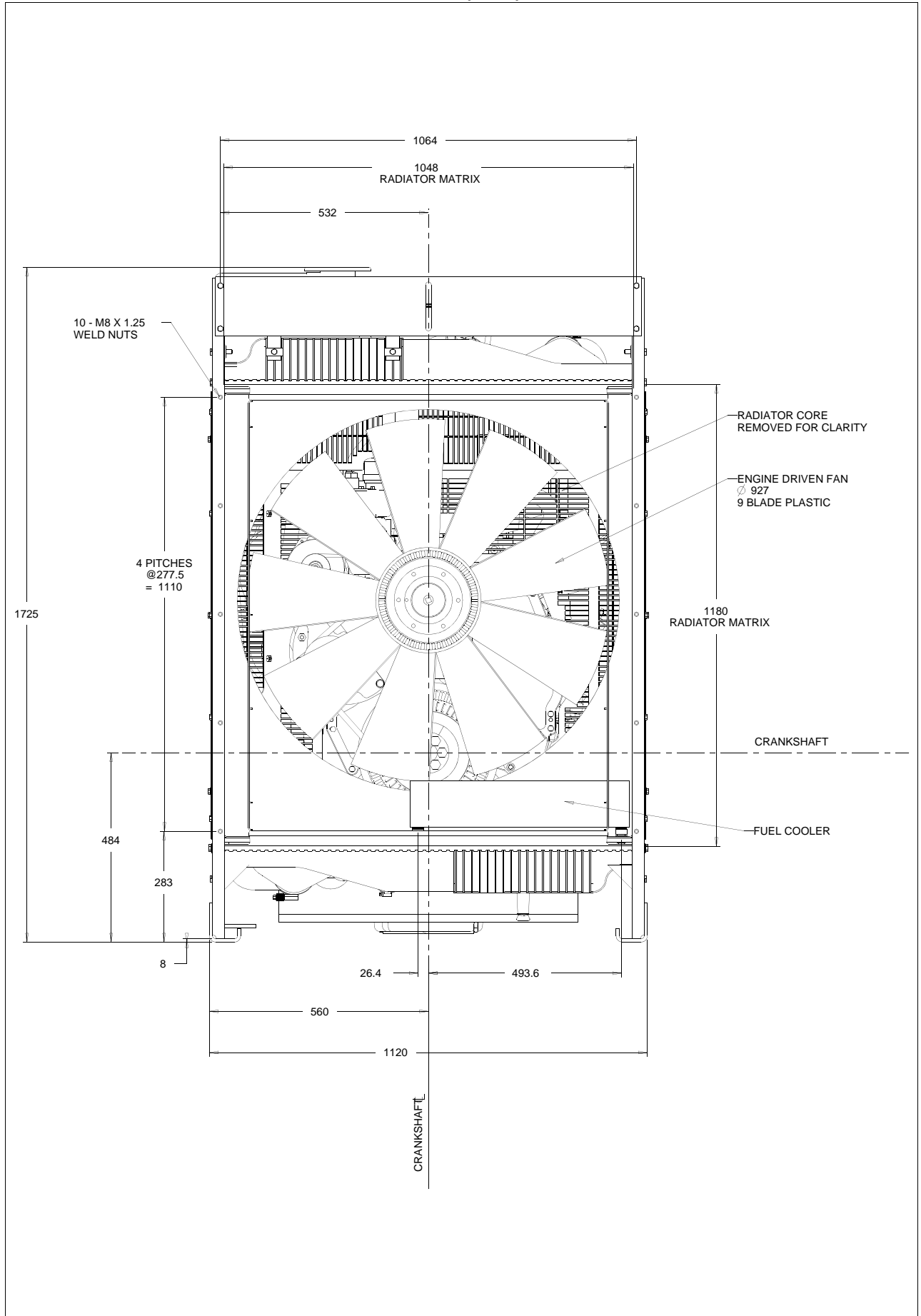

2206A-E13TAG2 and 2206A-E13TAG3 - GA Z13620 (50Hz)

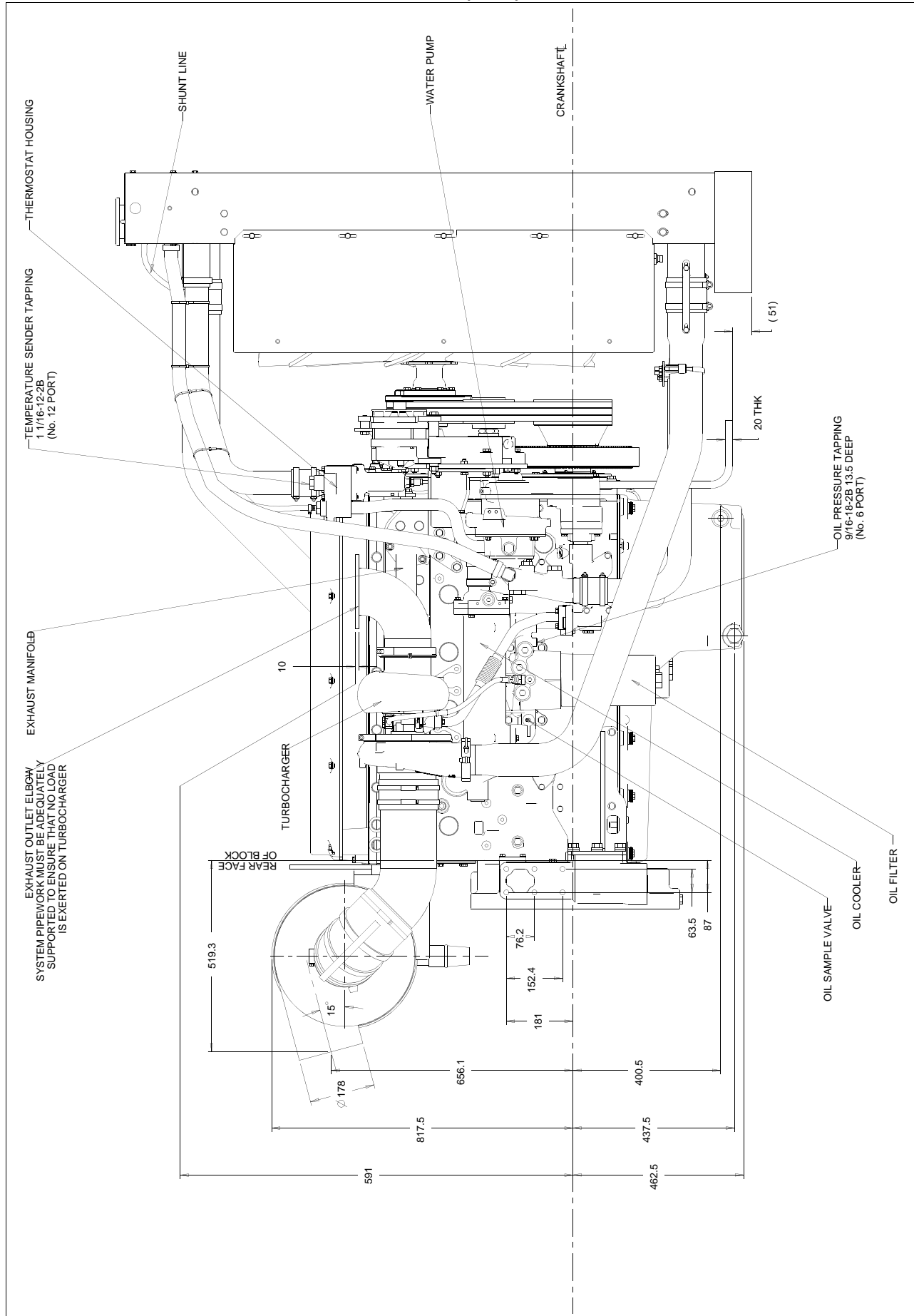

2206A-E13TAG2 and 2206A-E13TAG3 - GA Z13620 (50Hz)

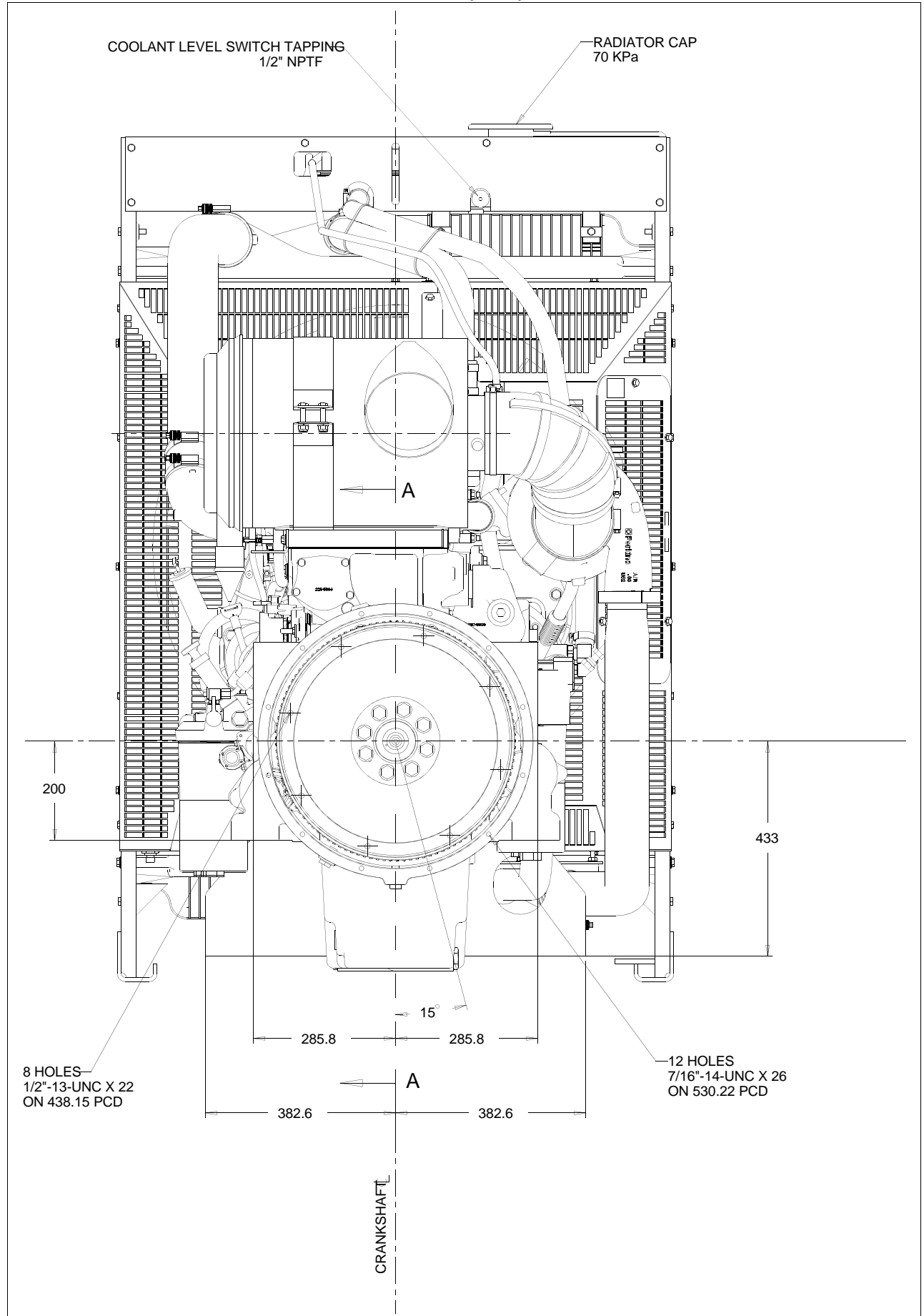

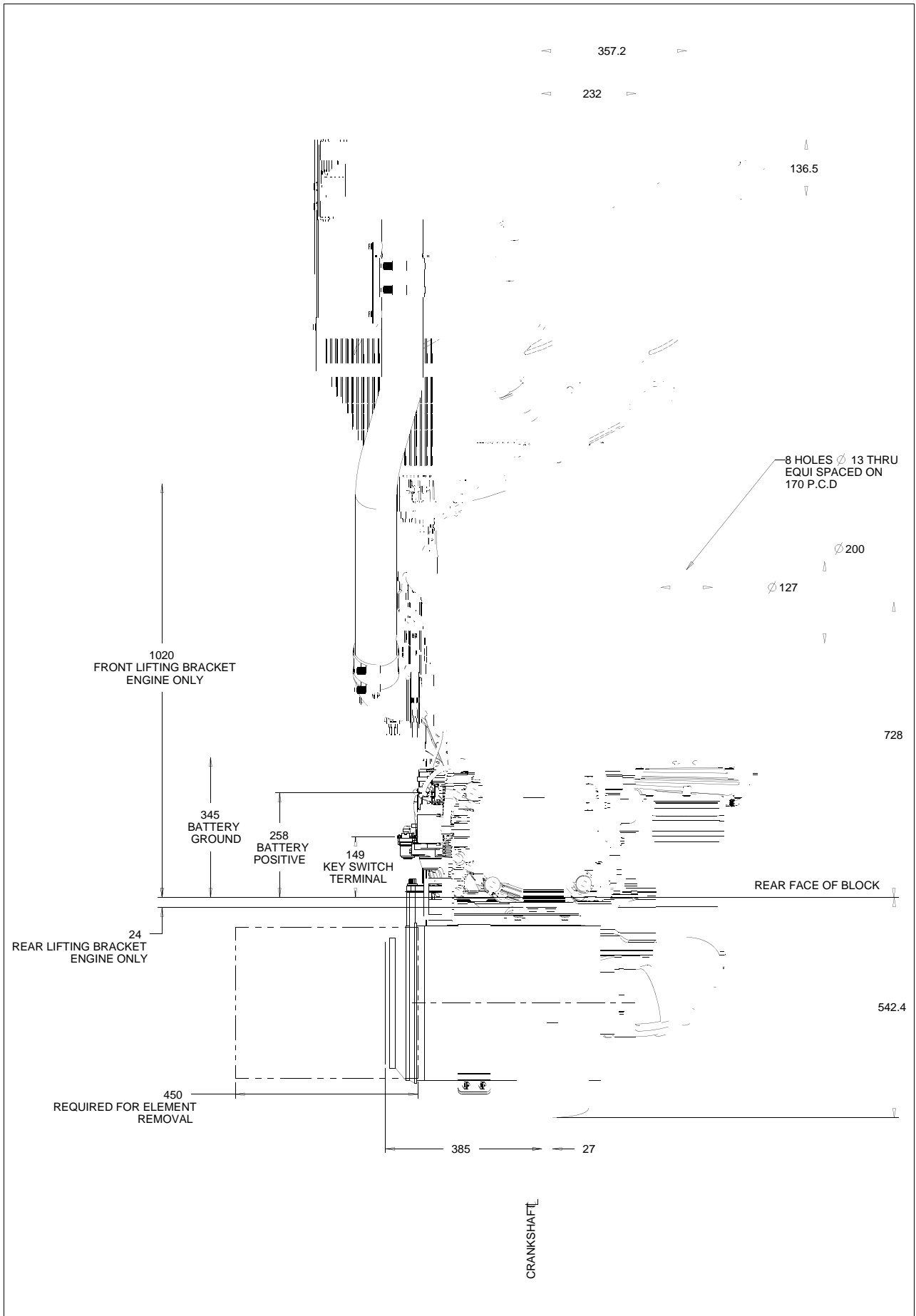

**2206A-E13TAG2 and 2206A-E13TAG3 - GA Z13620 (50Hz)**

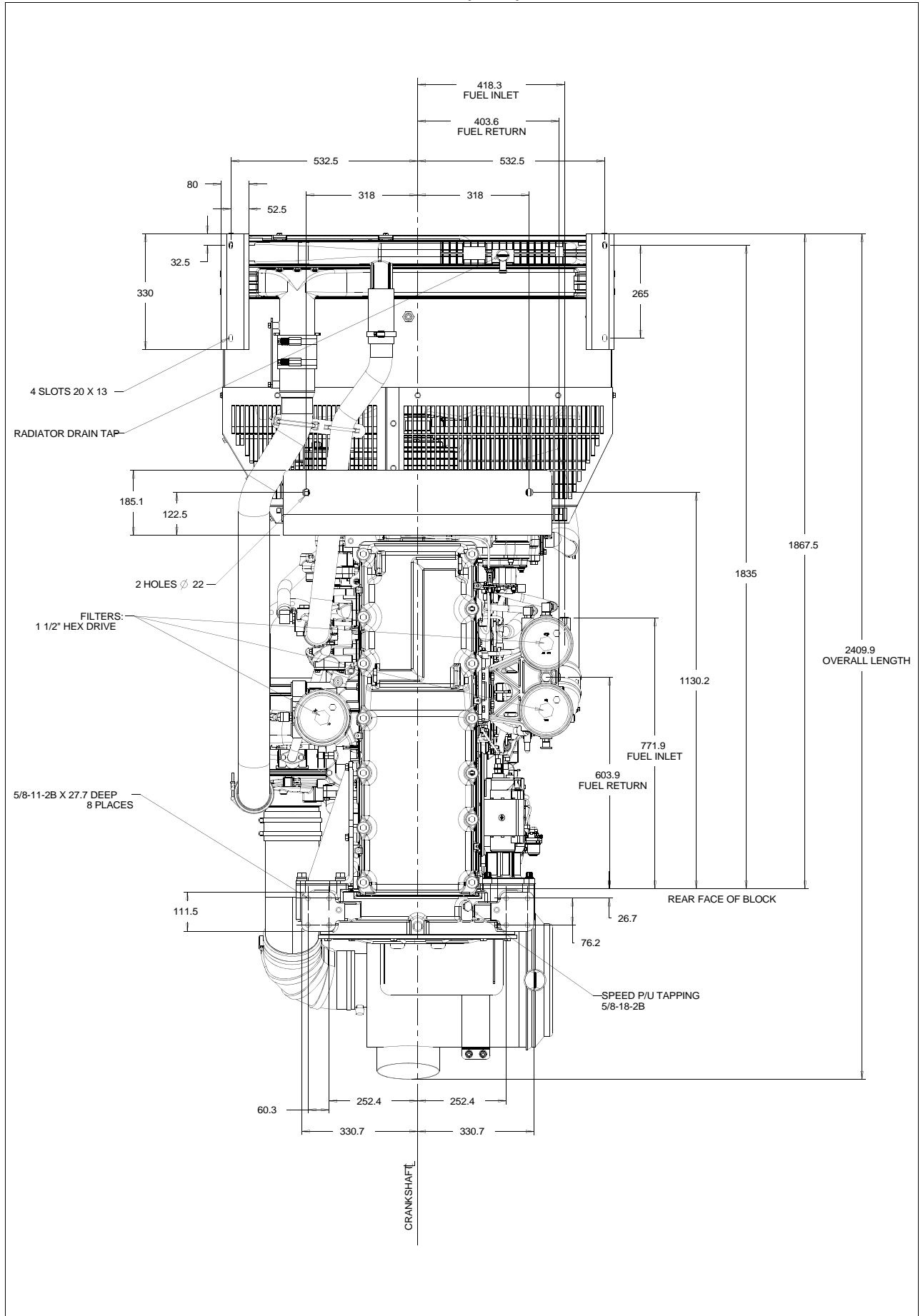

# 2206A-E13TAG2 and 2206A-E13TAG3 - GA Z13620 (50Hz)

SCRAP VIEW SHOWING DETAILS OF REAR LIFTING EYE

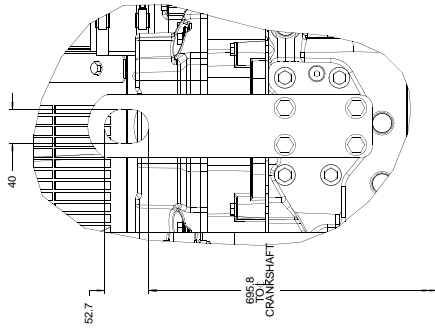

SCALE 1:2

SCRAP VIEW SHOWING DETAILS OF FRONT LIFTING EYE

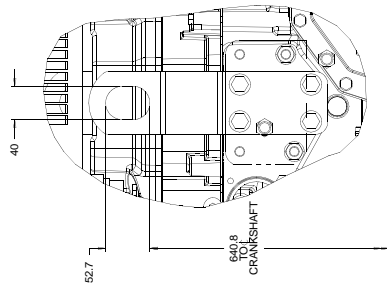

SCALE 1:2

SCRAP VIEW SHOWING DETAILS OF SHUNT PIPE CONNECTION

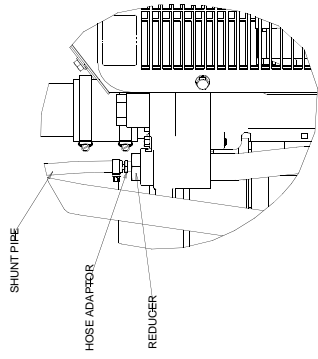

SCALE 1:2

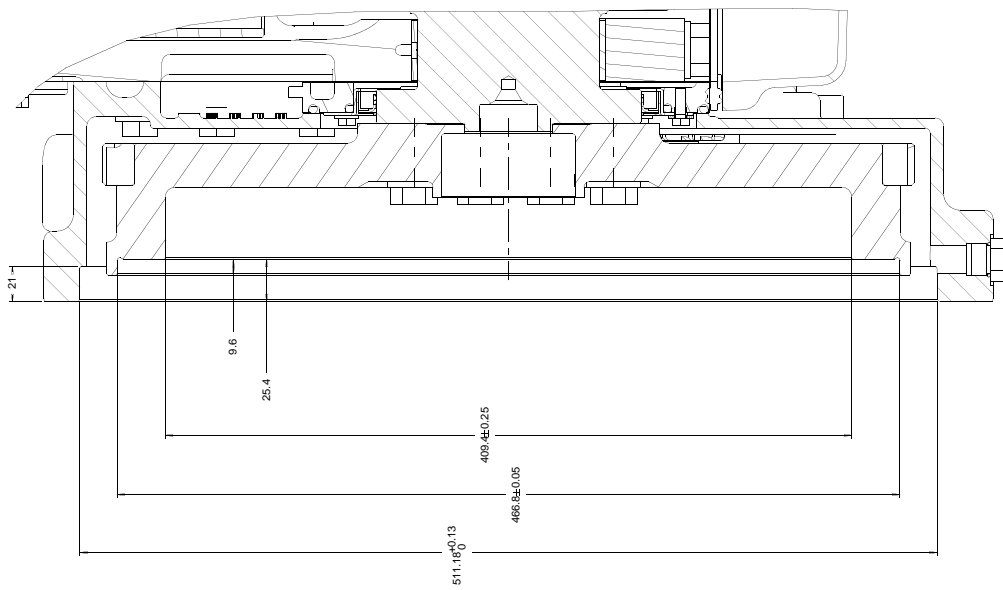

SCALE 1:1  
SECTIONAL SHEET 1)  
CROSS SECTIONAL VIEW OF FLYWHEEL HOUSING  
DETAILS OF SAE J817 SIZE 1 FLYWHEEL HOUSING  
AND SAE J860 SIZE 14 FLYWHEEL

KEY SWITCH TERMINAL M5 X 0.8  
TORQUE TO 2.0 - 2.5 Nm  
(1.5 - 1.8 ft lb)

BATTERY TERMINAL M12 X 4-75  
TORQUE TO 7.5 Nm  
(5.5 - 5.6 ft lb)

GROUND TERMINAL M12 X 4-75  
TORQUE TO 7.5 Nm  
(5.5 - 5.6 ft lb)

INDICATOR LIGHT  
M4 X 0.7  
TORQUE TO  
2.25 Nm

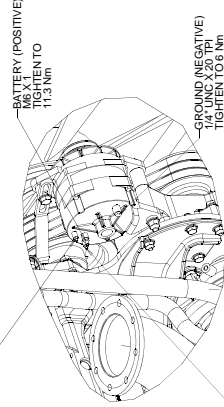

SCRAP VIEW SHOWING BATTERY CHARGING ALTERNATOR CONNECTIONS

SCALE 3:10

SCRAP VIEW SHOWING STARTER MOTOR CONNECTIONS

SCALE 3:10

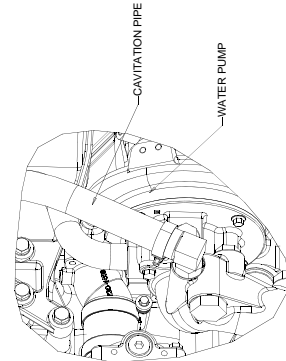
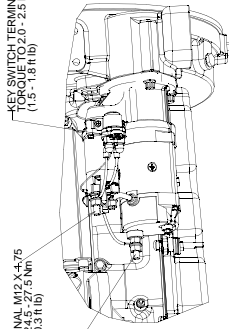

SCRAP VIEW SHOWING CAVITATION PIPE CONNECTION TO WATER PUMP  
(159000685)  
(3060042)



## Cooling system

### Radiator

Face area . . . . . 1,238 m<sup>2</sup>  
 Number of rows and materials . . . . . 1 rows, aluminium  
 Matrix density and material . . . . . 12 fins per inch, aluminium  
 Width of matrix . . . . . 1048 mm  
 Height of matrix . . . . . 1100 mm  
 Weight of radiator (dry) . . . . . 132 kg  
 Pressure cap setting (min) . . . . . 70 kPa

### Charge cooler

Face area . . . . . 1,006 m<sup>2</sup>  
 Number of rows and materials . . . . . 1 rows, aluminium  
 Matrix density and material . . . . . 12 fins per inch, aluminium  
 Width of matrix . . . . . 915 mm  
 Height of matrix . . . . . 1100 mm

### Coolant pump

Speed @ 1500 rev/min . . . . . 2056 rev/min  
 Speed @ 1800 rev/min . . . . . 2468 rev/min  
 Drive method. . . . . Gear

### Fan

Diameter . . . . . 927 mm  
 Drive ratio. . . . . 0,92:1  
 Number of blades. . . . . 9  
 Material . . . . . composite  
 Type . . . . . pusher  
 Cooling fan air flow @ 1500 rev/min . . . . . 654 m<sup>3</sup>/min  
 Cooling fan air flow @ 1800 rev/min . . . . . 788 m<sup>3</sup>/min

### Coolant

Total system capacity . . . . . 51,4 litres  
 Max. top tank temperature . . . . . 104 °C  
 Temperature rise across engine . . . . . 10 °C  
 Max. pressure in engine cooling circuit. . . . . 70 kPa  
 Max. permissible external system resistance . . . . . 30 kPa  
 Max. static pressure head on pump. . . . . 30 kPa  
 Coolant flow (min) against 30 kPa restriction  
 @ 1500 rev/min. . . . . 5,3 litres/sec  
 @ 1800 rev/min. . . . . 6,7 litres/sec  
 Thermostat operation range. . . . . 87 to 98°C  
 For details of recommended coolant specifications, refer to the  
 Operation and Maintenance Manual for this engine model

## Duct allowance

Duct allowance 2206A-E13TAG2 - standby			
Maximum additional restriction (duct allowance) to cooling airflow and resultant minimum airflow			
Engine speed rev/min	Ambient clearance inhibited coolant °C	Duct allowance Pa	m <sup>3</sup> /min
1500	59	200	563
1800	59	200	716

Duct allowance 2206A-E13TAG3 - standby			
Maximum additional restriction (duct allowance) to cooling airflow and resultant minimum airflow			
Engine speed rev/min	Ambient clearance inhibited coolant °C	Duct allowance Pa	m <sup>3</sup> /min
1500	55	200	563
1800	59	200	716

## Electrical system

-type	24 Volt negative earth
Alternator type	.22SI
-alternator voltage	.24V
-alternator output	.70A
Starter motor type	.39MT
-starter motor voltage	.24V
-starter motor power	.7,8 kW
Number of teeth on flywheel	.113
Number of teeth on starter pinion	.11
Minimum cranking speed	.106 rev/min
Starter solenoid maximum	
-pull-in current @ 0°C	.200A
-hold-in current @ 0°C	.25A

### Cold start recommendations

#### -5°C to -10°C

oil	SAE grade 15W40
Starter	.42MT
Battery	.24 volts
Max. breakaway current	.1311 amps
Cranking current	.588 amps
Starting aids (ECM controlled)	.none
Min. mean cranking speed	.106 rev/min

#### -11°C to -25°C

oil	SAE grade 5W40
Starter	.42MT
Battery	.24 volts
Max. breakaway current	.1585 amps
Cranking current	.828 amps
Starting aids (ECM controlled)	.block heater 1,5kW (110V/240V)
Min. mean cranking speed	.106 rev/min

#### Notes:

- Battery capacity is defined by the 20 hour rate
- The oil specification should be for the minimum ambient temperature as the oil will not be warmed by the immersion heater
- Breakaway current is dependent on the battery capacity available. Cables should be capable of handling transient current twice that of cranking current.

## Exhaust system

### Maximum back pressure

-1800 rev/min	.10,0 kPa
Exhaust outlet, internal diameter	.123 mm

## Fuel system

Injection system	.MEUI
Injector type	.MEUI
Governor type	.electronic
Governing conforms to	.ISO 8528-5 Class G2
Injector pressure	.207 MPa

### Fuel lift pump

-lift pump type	.gear driven
-lift pump delivery @ 1500 rev/min	.480 litres/hour
-lift pump delivery @ 1800 rev/min	.600 litres/hour
-lift pump delivery pressure	.621 kPa
-max. suction head at pump inlet	.3 m
-max. static pressure head	.4 m
-max. fuel inlet temperature	.55 °C
-fuel filter spacing primary	.10 microns
-fuel filter spacing secondary	.2 microns

### Fuel specification

BS2869 Class A2 or BSEN590  
ASTM D975 Class 1D and class 2D

**Note:** For further information on fuel specifications and restrictions, refer to the OMM, "Fluid Recommendations" for this engine model.

## Induction system

### Maximum air intake restriction

-clean filter	.2,5 kPa
-dirty filter	.6,4 kPa
-air filter type	.paper element - 15 inch diameter

## Lubrication system

Maximum total system oil capacity ... 40 litres  
 Minimum oil capacity in sump ... 32,5 litres  
 Maximum oil capacity in sump ... 38 litres  
 Maximum engine operating angles -  
 front up, front down, right side, left side ... 7 °

### Lubricating oil

-oil flow @ 1500 rev/min ... 140 litres/min  
 -oil flow @ 1800 rev/min ... 172 litres/min  
 -oil pressure at bearings @ 1500 rev/min ... 310 kPa  
 -oil pressure at bearings @ 1800 rev/min ... 358 kPa  
 -oil pressure at bearings (min) ... 270 kPa  
 -oil temperature (continuous operation) ... 113 °C  
 -oil consumption at full load as a % of fuel consumption ... 0.15%  
 Oil filter screen spacing ... 30 microns  
 Oil consumption as % of fuel consumption ... 0,1  
 Sump drain plug tapping ... 1/8 UNF  
 Lubricating oil specification ... API-CH4 - SAE15W-40

### Recommended SAE viscosity

Engine Oil Viscosity		
EMA LRG-1 API CH-4 Viscosity Grade	Ambient Temperature	
	Minimum	Maximum
SAE 0W20	-40 °C	10 °C
SAE 0W30	-40 °C	30 °C
SAE 0W40	-40 °C	40 °C
SAE 5W30	-30 °C	30 °C
SAE 5W40	-30 °C	40 °C
SAE 10W30	-20 °C	40 °C
SAE 15W40	-10 °C	50 °C

### Mountings

Maximum static bending moment at rear face of block ... 1356 Nm

## Fuel consumption

### 2206A-E13TAG2 - 1500 rev/min

Load	g/kWhr	l/hr
Standby	195	80
110% Prime power	195	77
100% Prime power	196	71
75% of Prime power	198	54
50% of Prime power	203	37

### 2206A-E13TAG3 - 1500 rev/min

Load	g/kWhr	l/hr
Standby	194	90
110% Prime power	196	89
100% Prime power	197	81
75% of Prime power	199	62
50% of Prime power	202	42

### 2206A-E13TAG2 - 1800 rev/min

Load	g/kWhr	l/hr
Standby	193	87
110% Prime power	195	88
100% Prime power	196	81
75% of Prime power	199	62
50% of Prime power	205	43

### 2206A-E13TAG3 - 1800 rev/min

Load	g/kWhr	l/hr
Standby	193	87
110% Prime power	195	88
100% Prime power	196	81
75% of Prime power	199	62
50% of Prime power	205	43

All fuel consumption figures are based on Nett power

Load acceptance

TAG2 (cold)

Initial load application: When engine reaches rated speed (15 seconds maximum after engine starts to crank)			
Descriptor	Units	50 Hz	60Hz
% of prime power	%	66	80
Load (nett)	kWm	184,8	256
Transient frequency deviation	%	<10	<10
Frequency recovery	Seconds	5	5

Second load application: When engine reaches rated speed (5 seconds after initial load application)			
Descriptor	Units	50 Hz	60Hz
% of prime power	%	73	85
Load (nett)	kWm	204,4	272
Transient frequency deviation	%	<10	<10
Frequency recovery	Seconds	5	5

TAG3 (cold)

Initial load application: When engine reaches rated speed (15 seconds maximum after engine starts to crank)			
Descriptor	Units	50 Hz	60Hz
% of prime power	%	58	80
Load (nett)	kWm	185,6	256
Transient frequency deviation	%	<10	<10
Frequency recovery	Seconds	5	5

Second load application: When engine reaches rated speed (5 seconds after initial load application)			
Descriptor	Units	50 Hz	60Hz
% of prime power	%	65	85
Load (nett)	kWm	208	272
Transient frequency deviation	%	<10	<10
Frequency recovery	Seconds	5	5

The information shown above complies with the requirements of classification 3 and 4 of ISO 8528-12 and G2 operating limits stated in ISO 8528-5

The above figures were obtained under the following test conditions:

- minimum engine block temperature... 45 °C
- ambient temperature... 15 °C
- governing mode ... isochronous
- alternator efficiency... 92%
- alternator inertia ... 6,9 kgm<sup>2</sup>
- under frequency roll off (UFRO) point set to... 1 Hz below rated
- UFRO rate set to... 2% voltage / 1% frequency
- LAM on/off... off

All tests were conducted using an engine which was installed and serviced to Perkins Engines Company Limited recommendations.

**Note:** The general arrangement drawings shown in this data sheet are for guidance only. For installation purposes, latest versions should be requested from the Applications Dept., Perkins Engines Stafford, ST16 3UB United Kingdom.



Perkins Engines Company Limited  
Peterborough PE1 5NA United Kingdom  
Telephone +44 (0) 1733 583000  
Fax +44 (0) 1733 582240  
www.perkins.com

Distributed by